

# Manuale di manutenzione *Maintenance guide*



PROCEDURA REVISIONE VALVOLE VOLUMETRICHE  
*MAINTENANCE INSTRUCTIONS METERING VALVES*

DAV 300 - DAV 400



## DAV TECH SRL

Via Ravizza, 30 - 36075 Montecchio Maggiore (VI) - ITALIA  
Tel. 0039 0444 574510 - Fax 0039 0444 574324

[davtech@davtech.it](mailto:davtech@davtech.it) - [www.davtech.it](http://www.davtech.it)

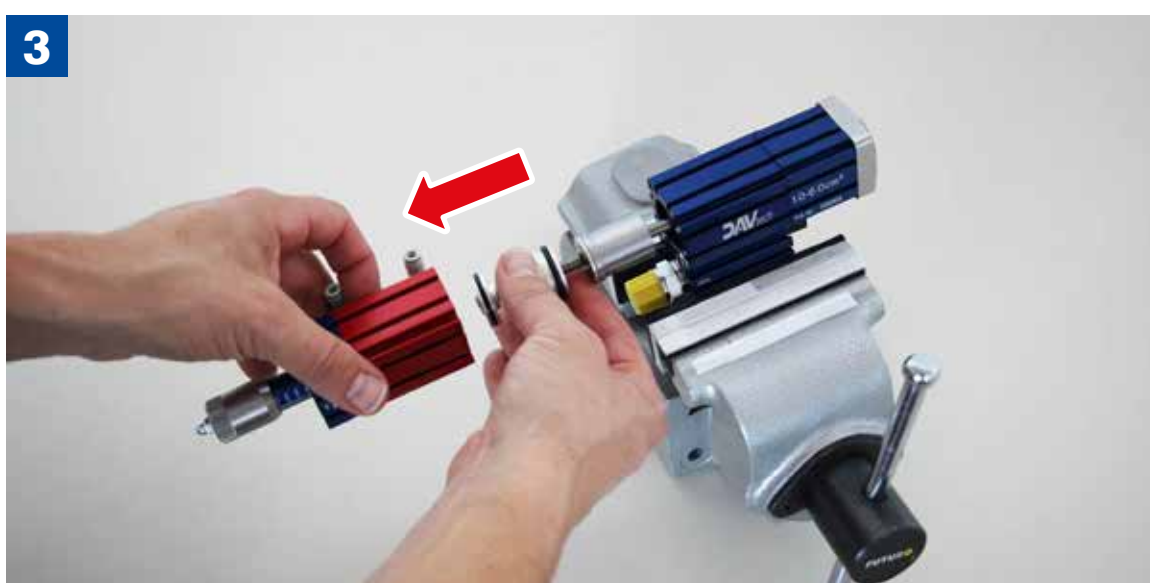
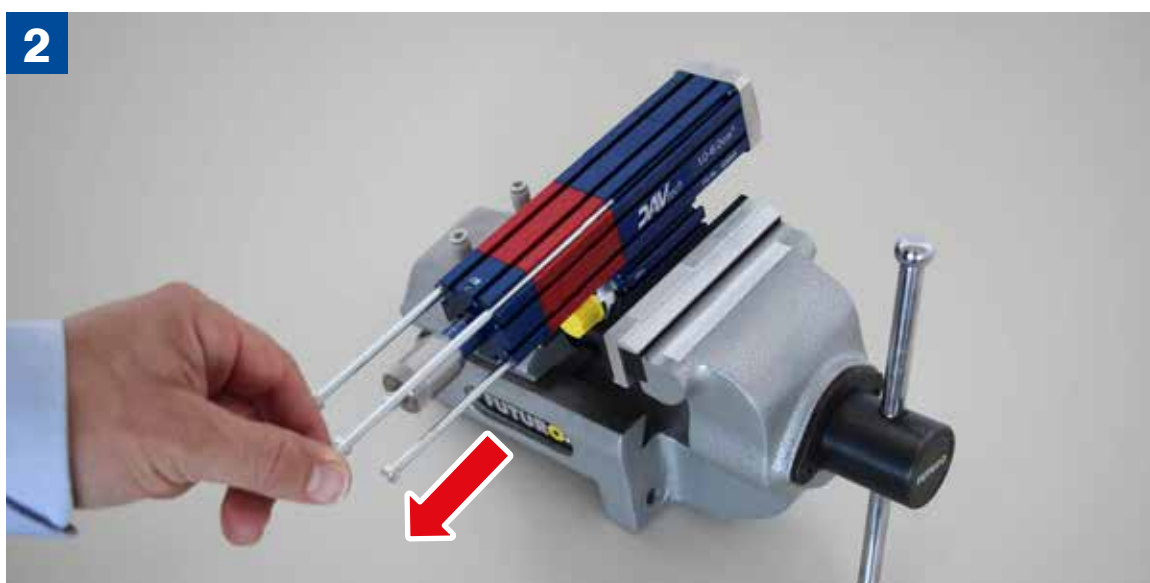

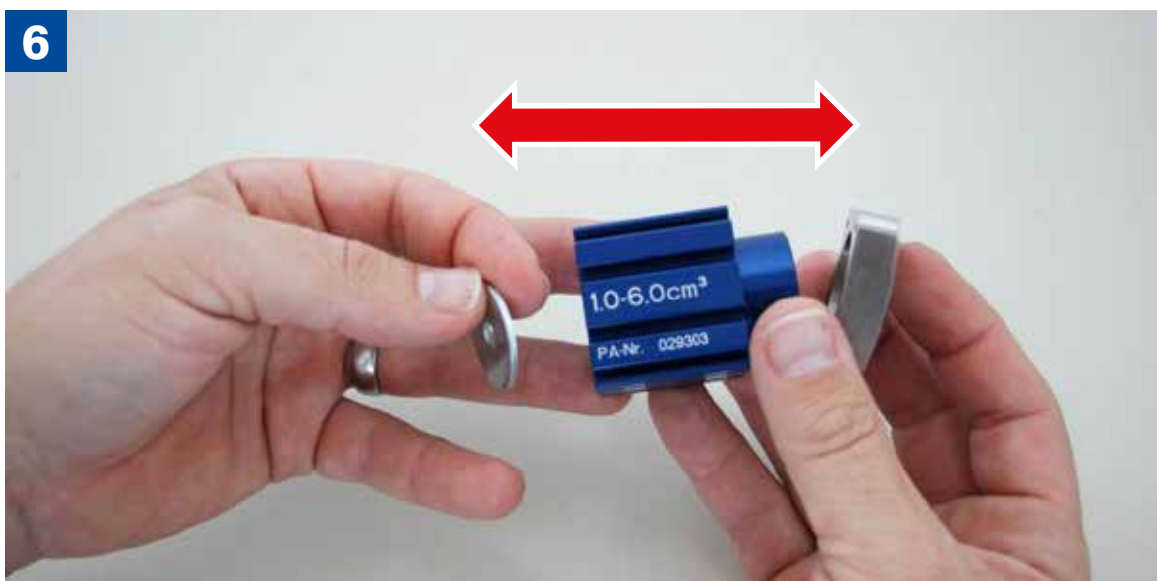
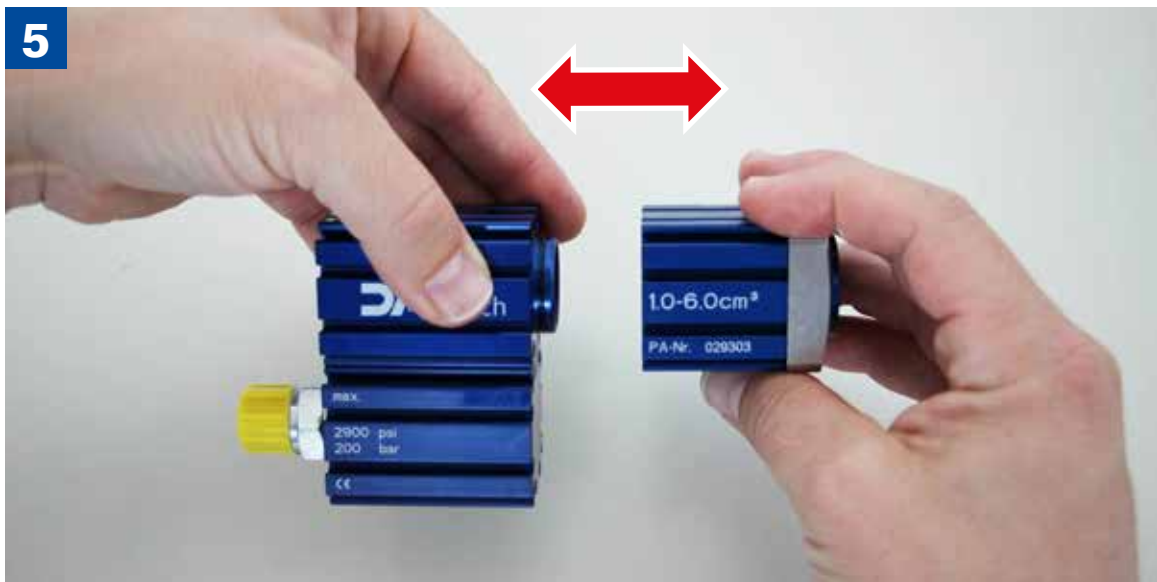
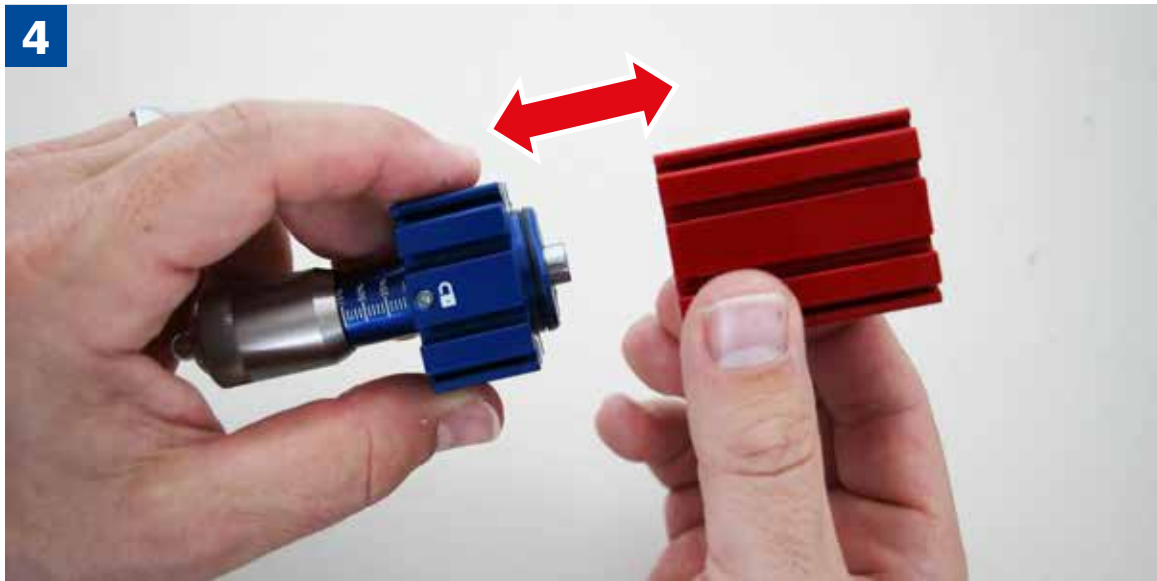

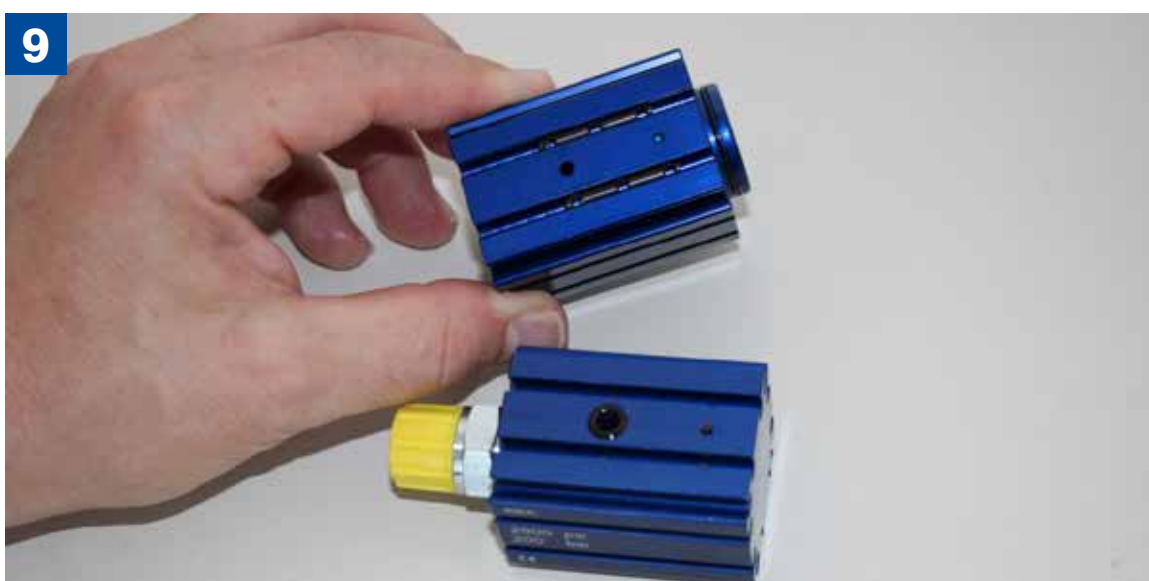



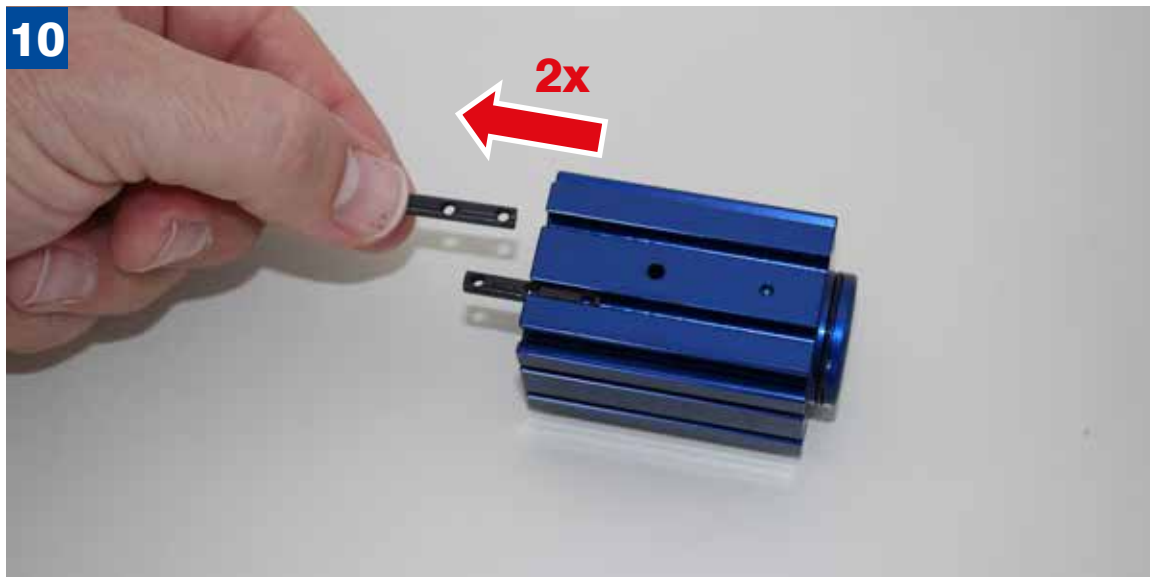

13



14



15



16



17

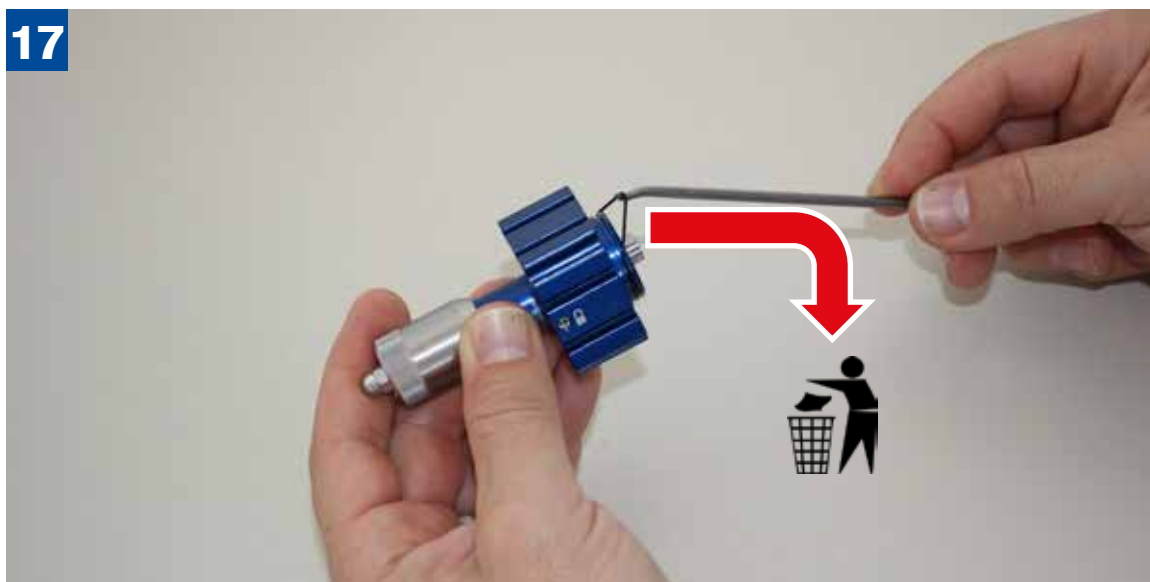

18

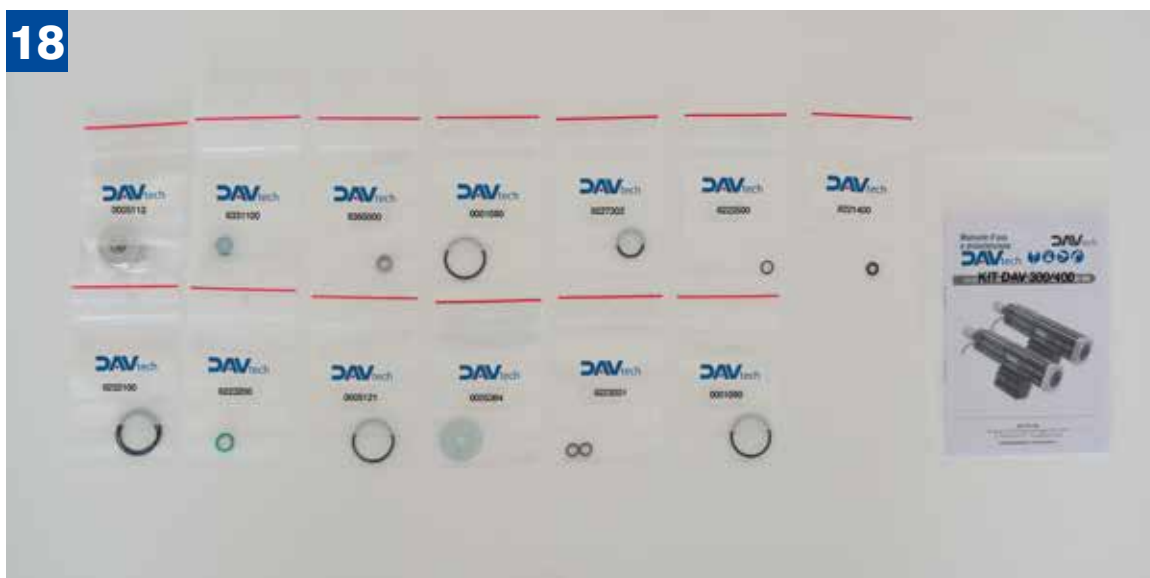

19

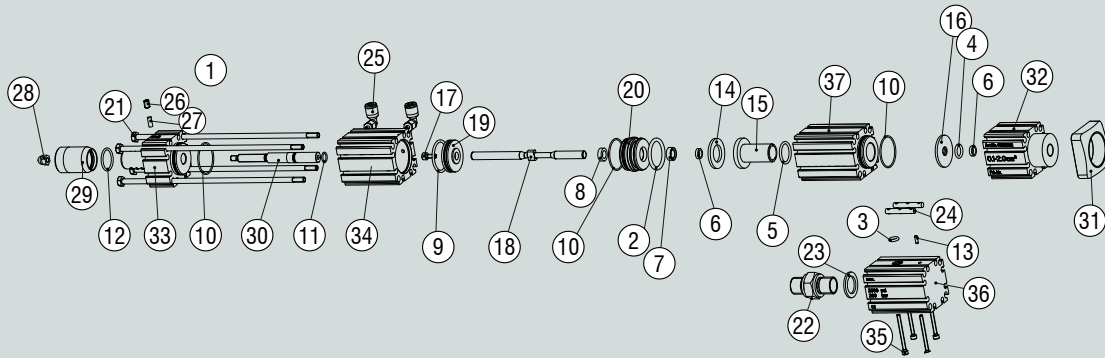

20



21





22

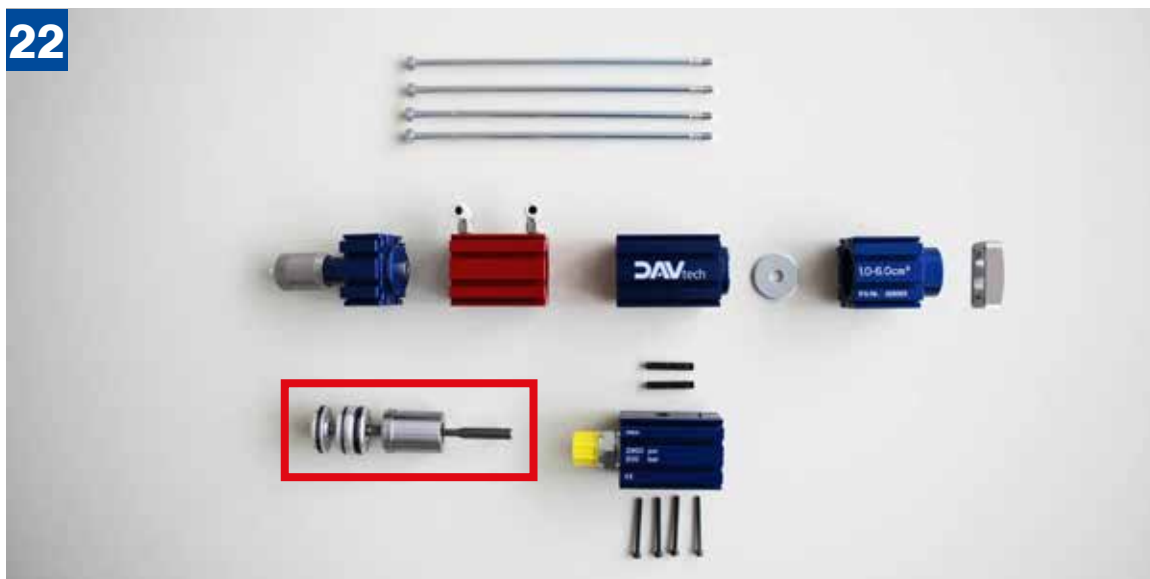

23



24



25



26



27

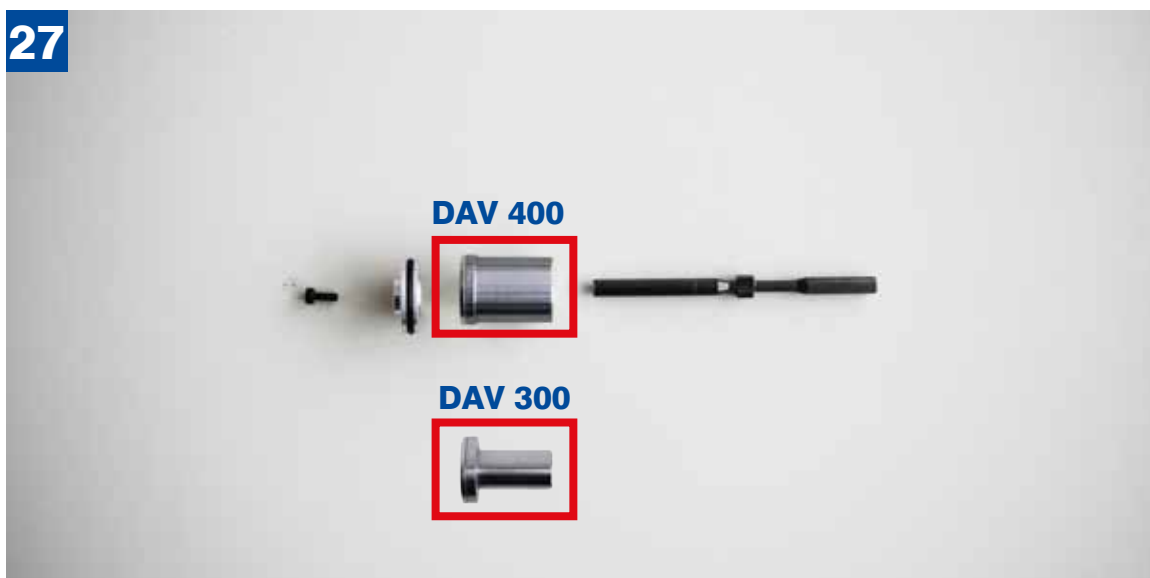

28



29



30



31

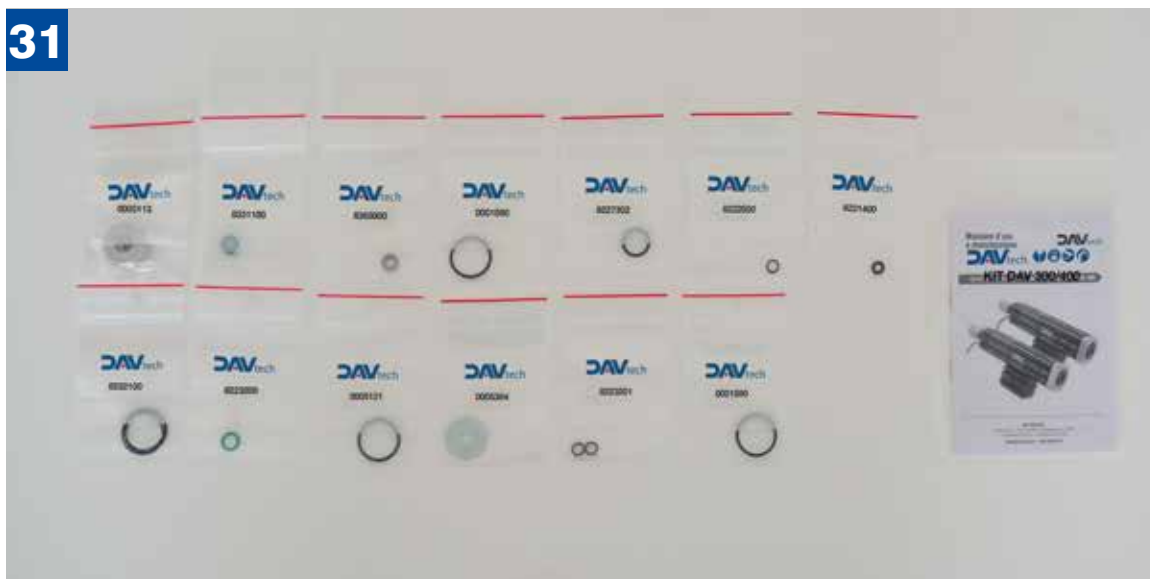

32



33



34



35

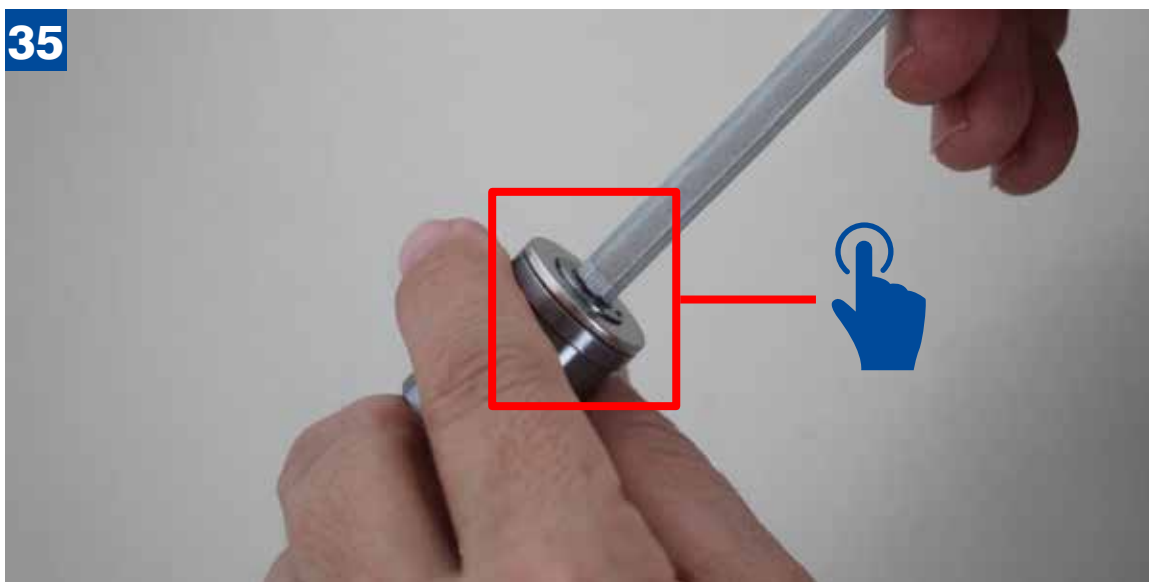

36





37



38



39

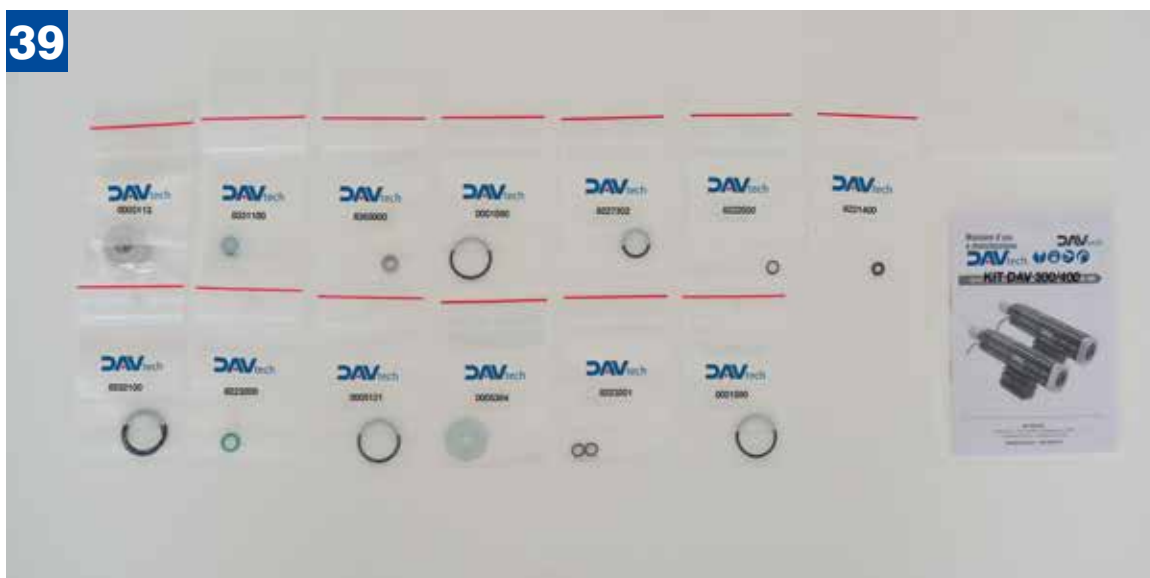

40



41

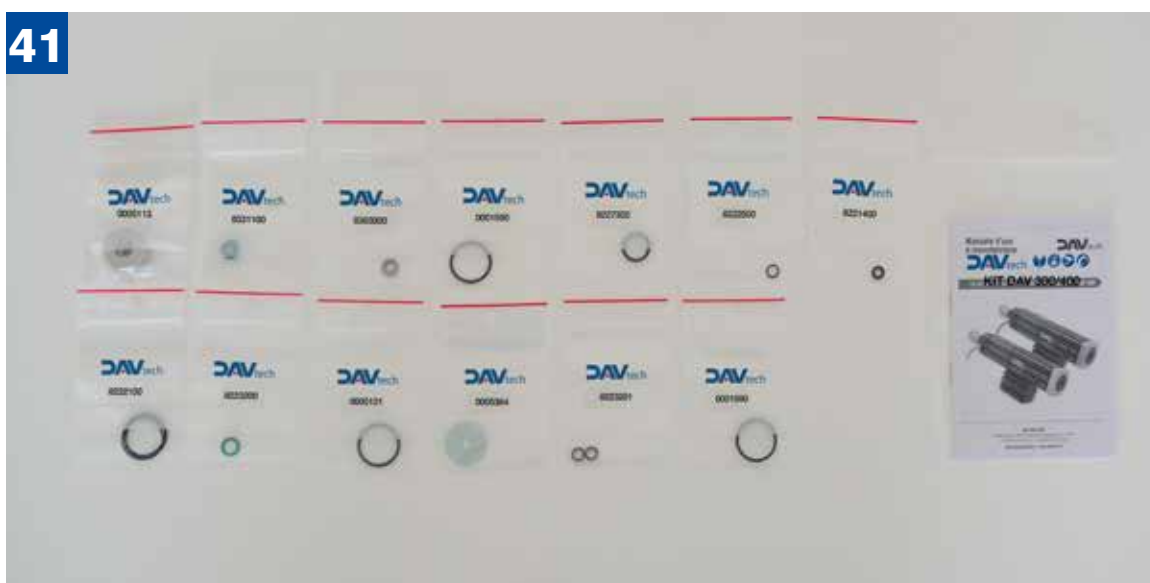

42



43



44



45



46

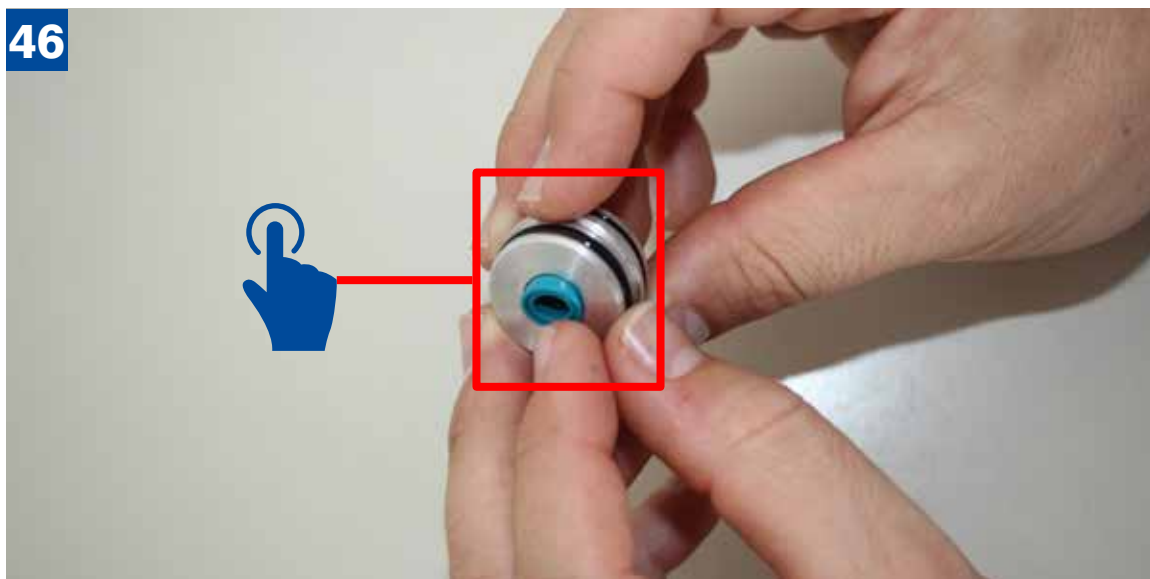

47



48



49



50



51

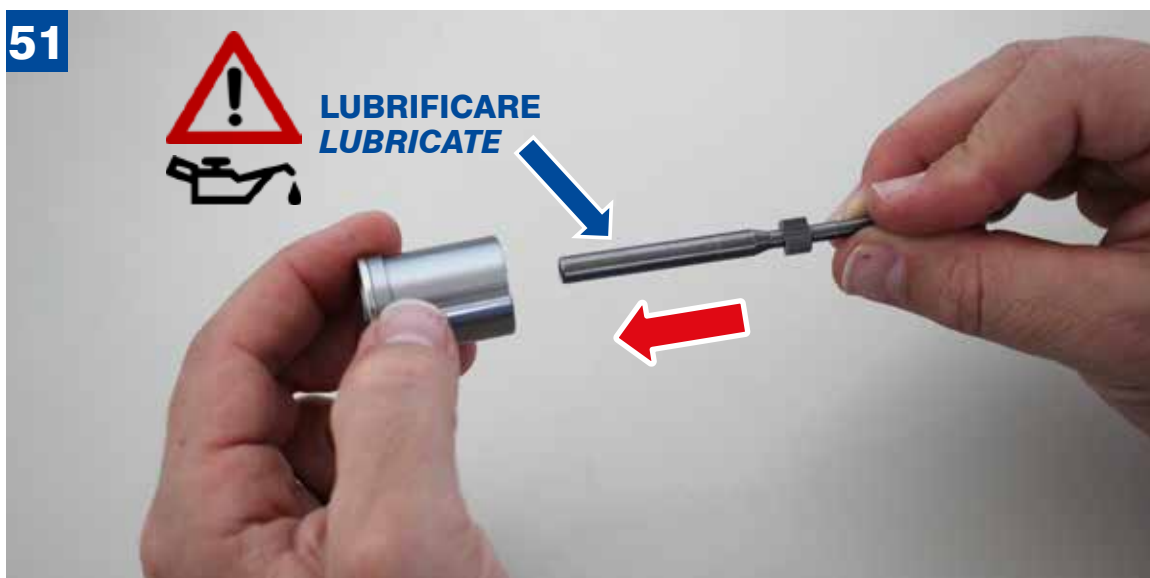



52



53



54

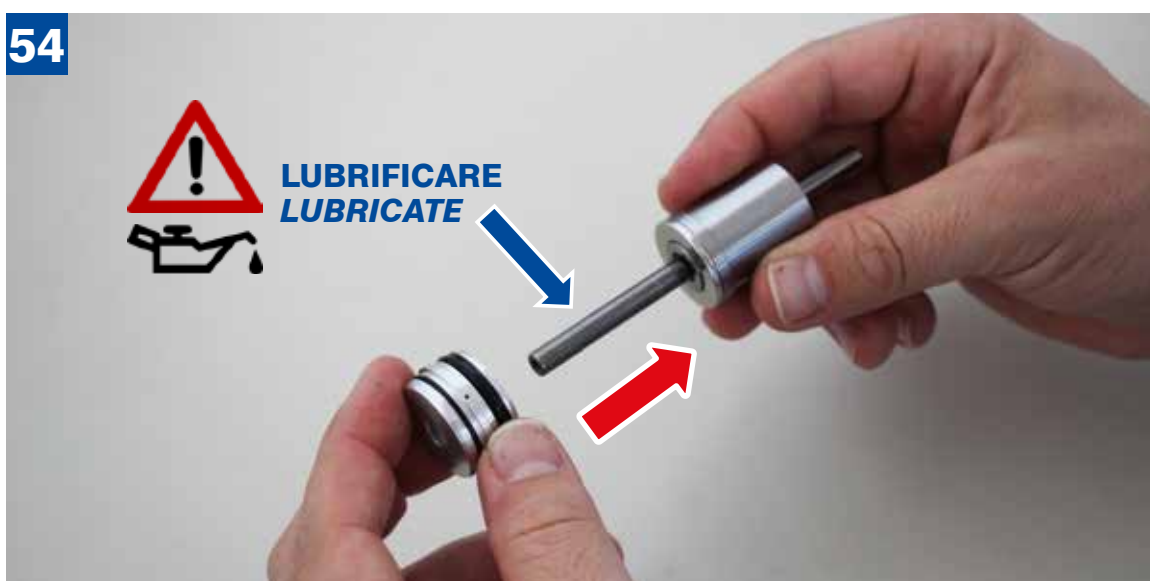

55



56



57



58



59



60



61

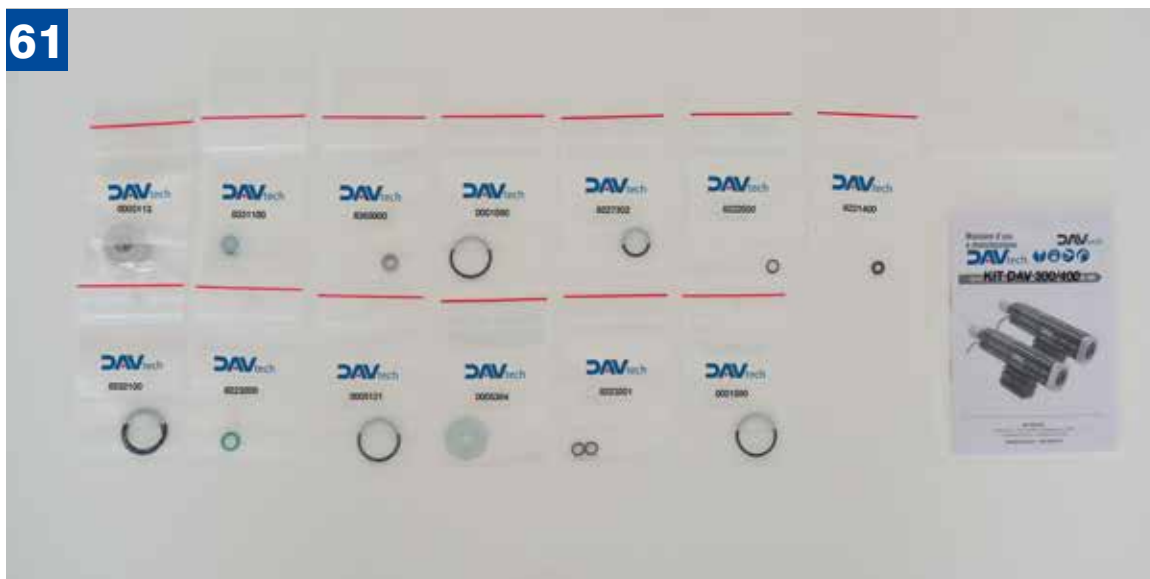

62



63



64

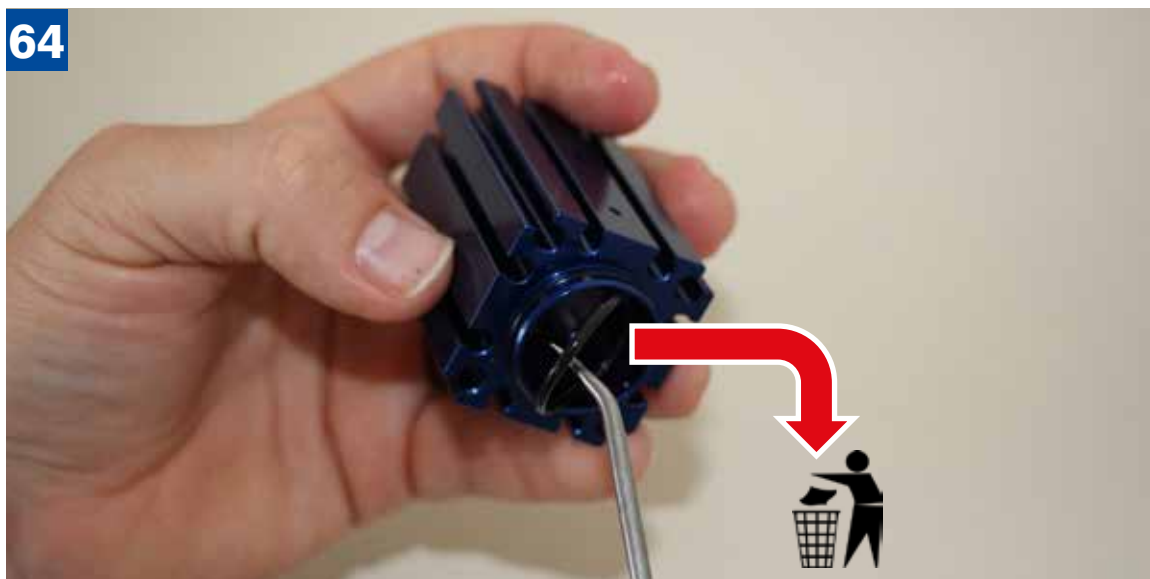

65

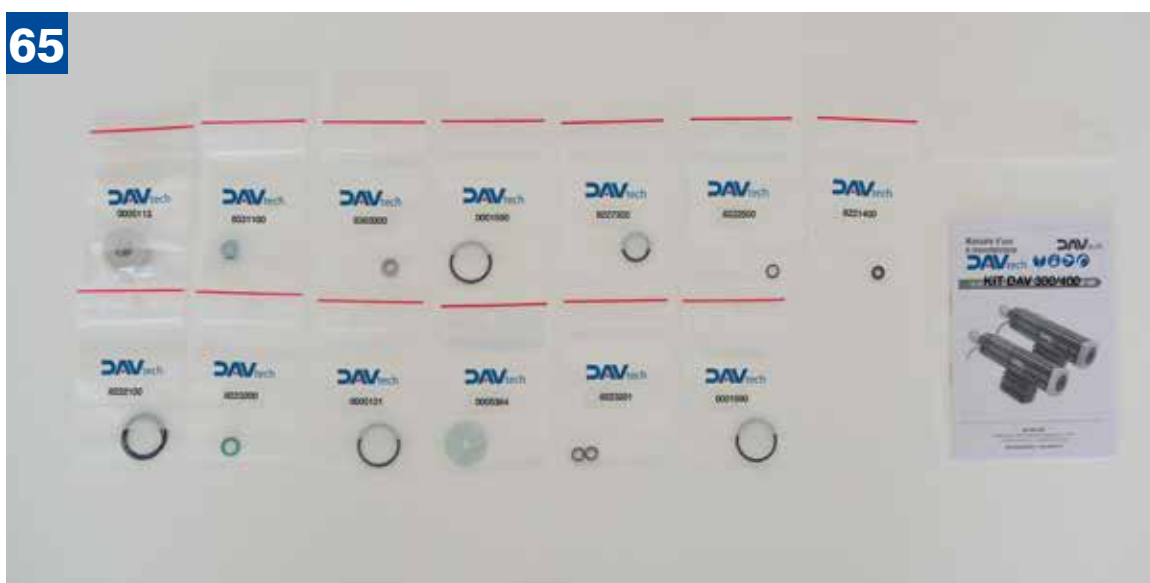

66





67



68

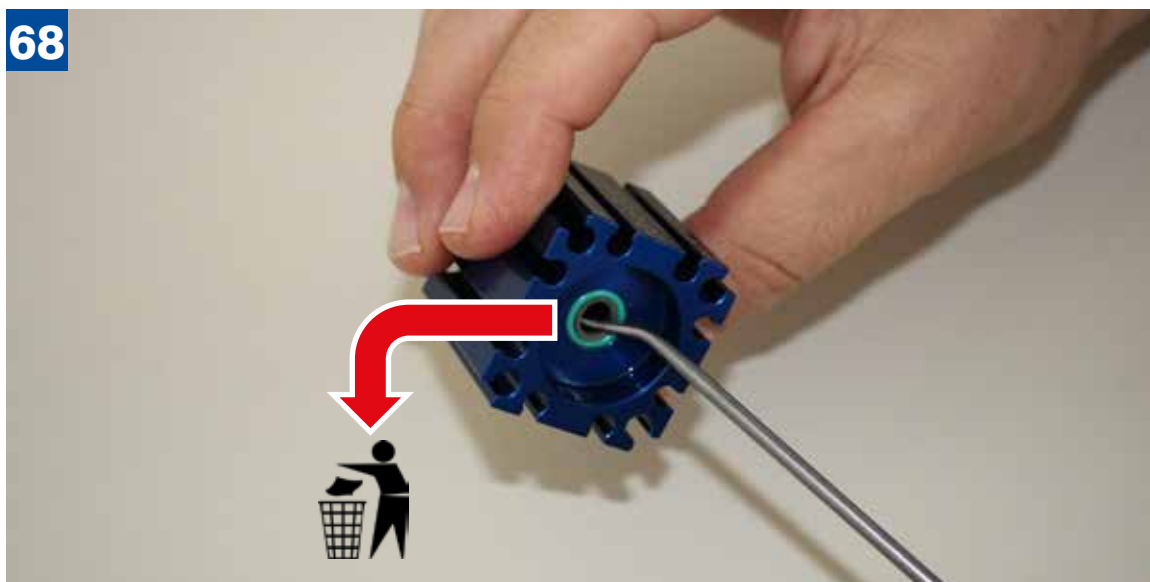

69

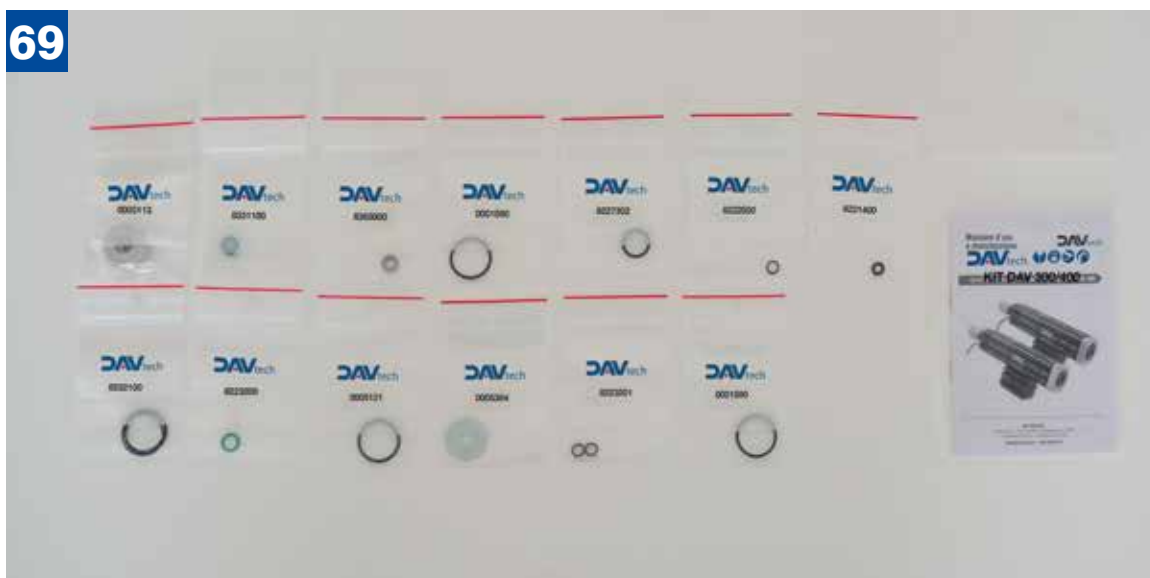

70



71

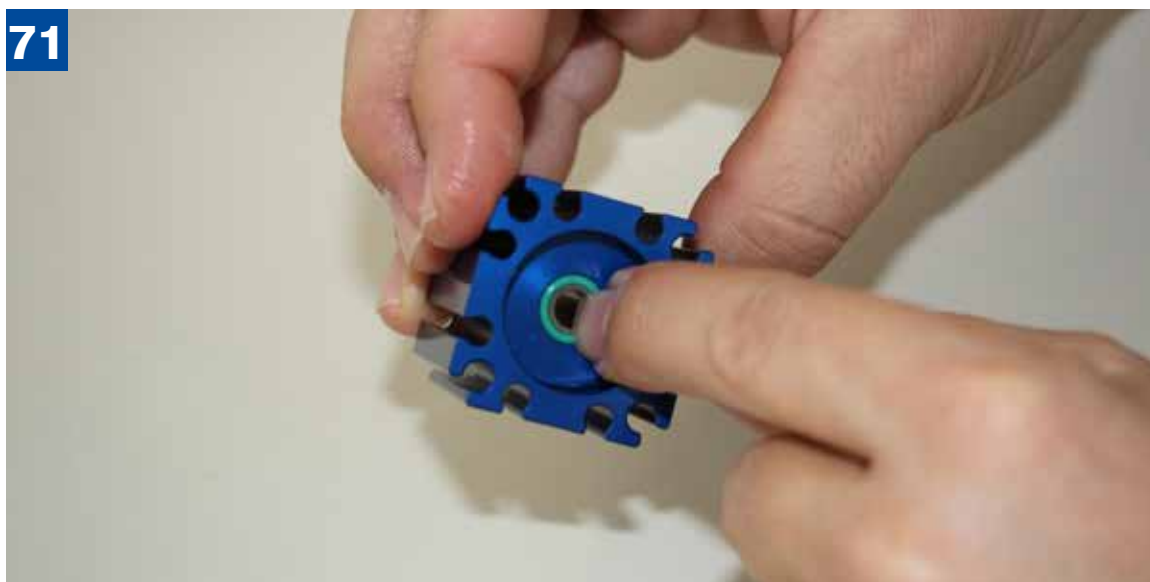

72



73

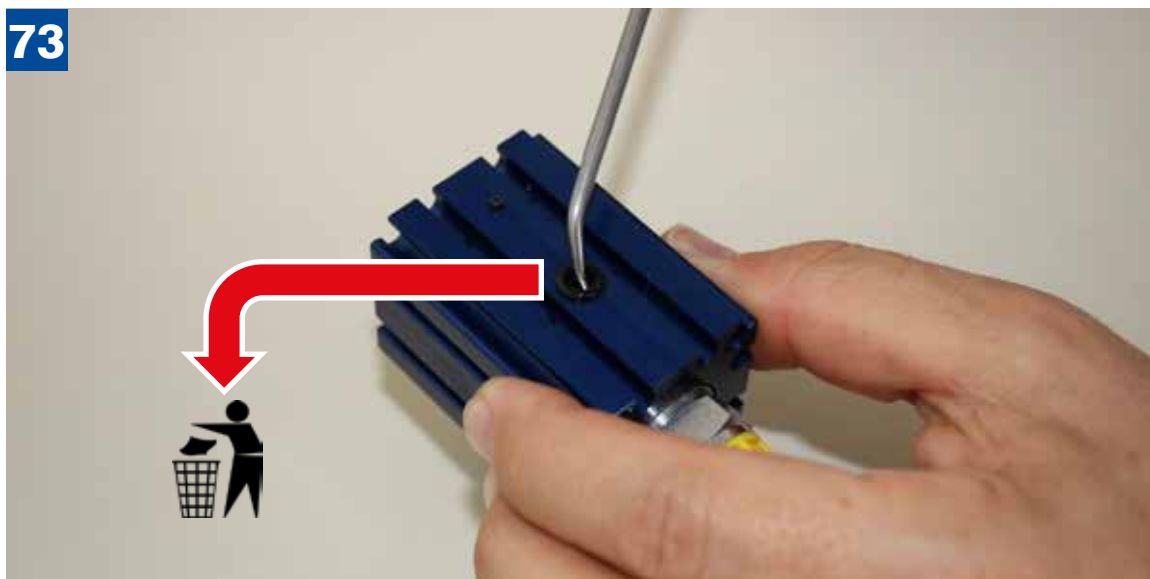

74

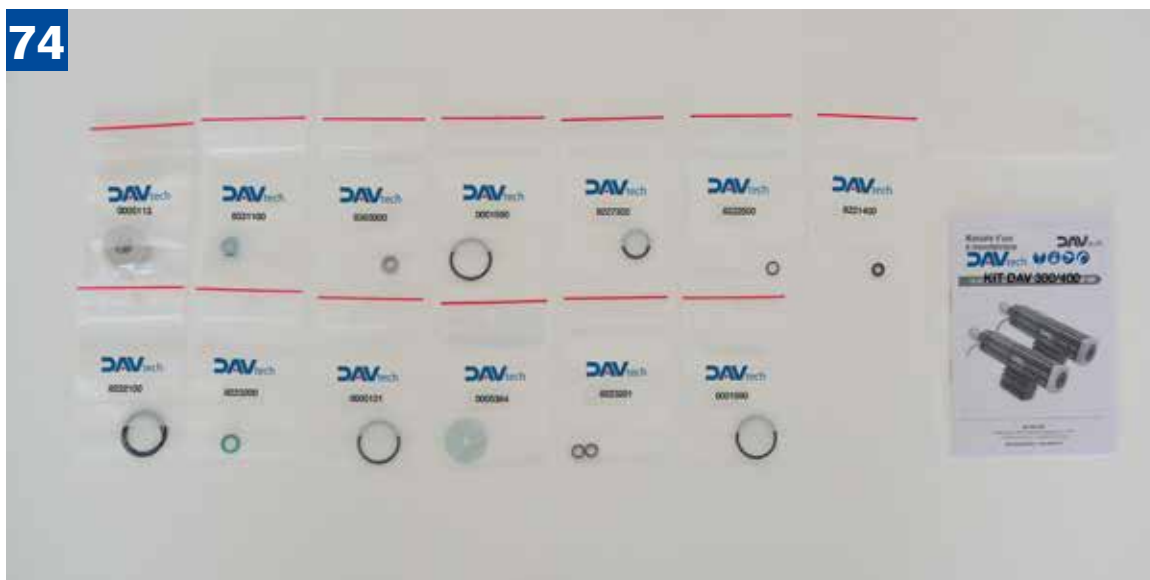

75



76

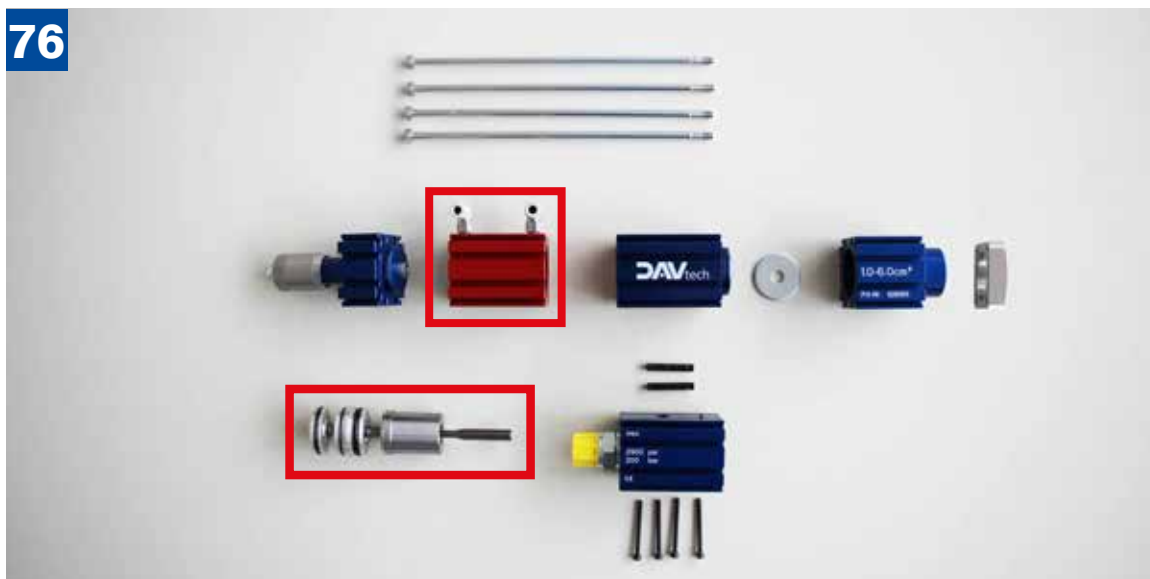

77

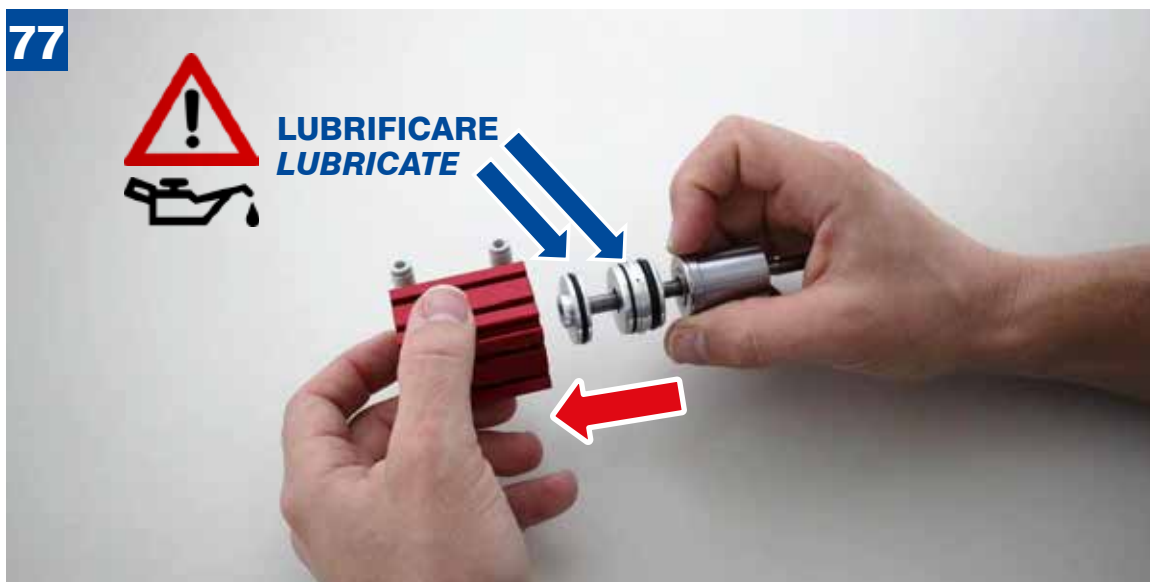

78



79



80



81





82



83



84



85

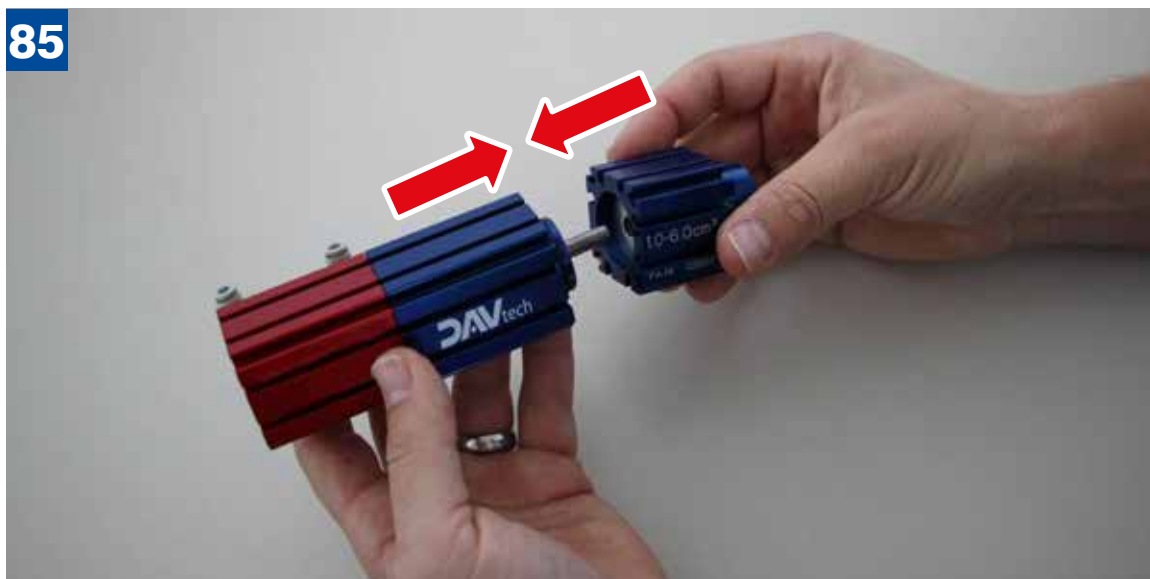

86



87



88



89



90



91



92



93

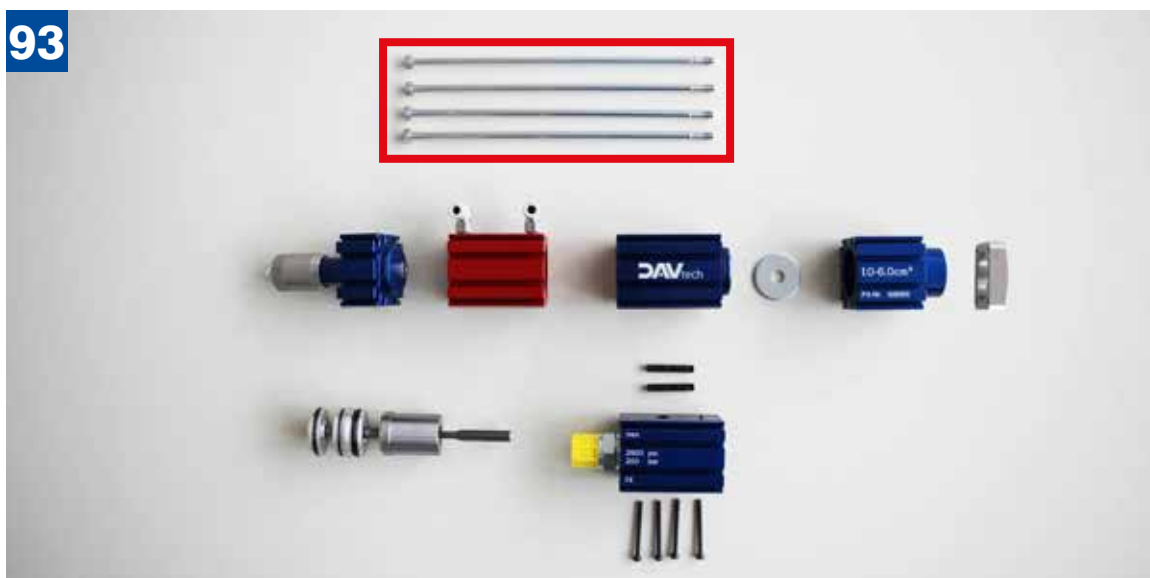

94

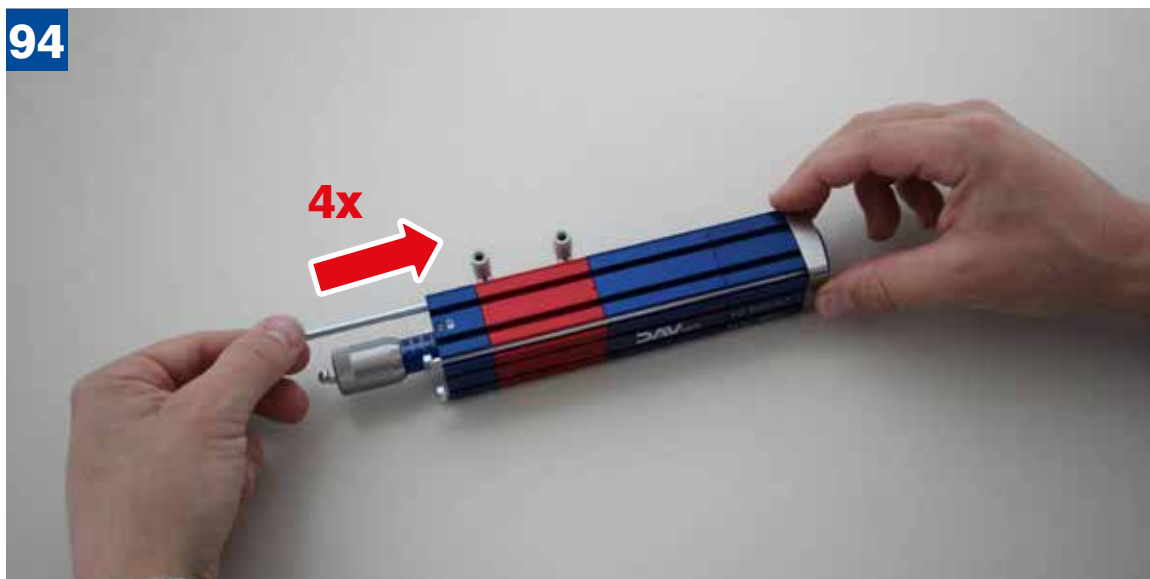

95

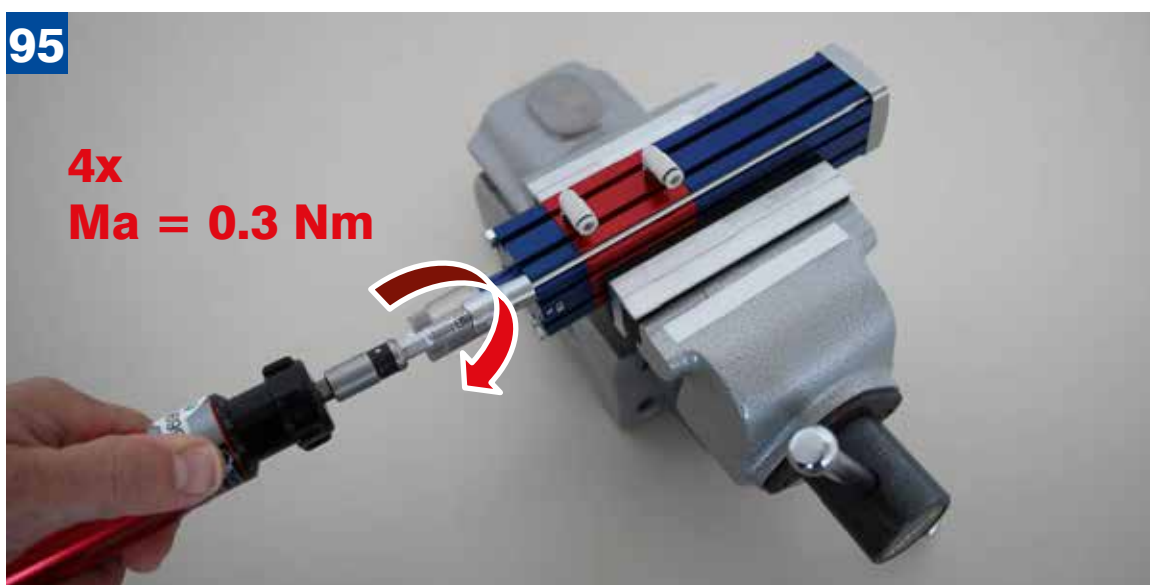

96





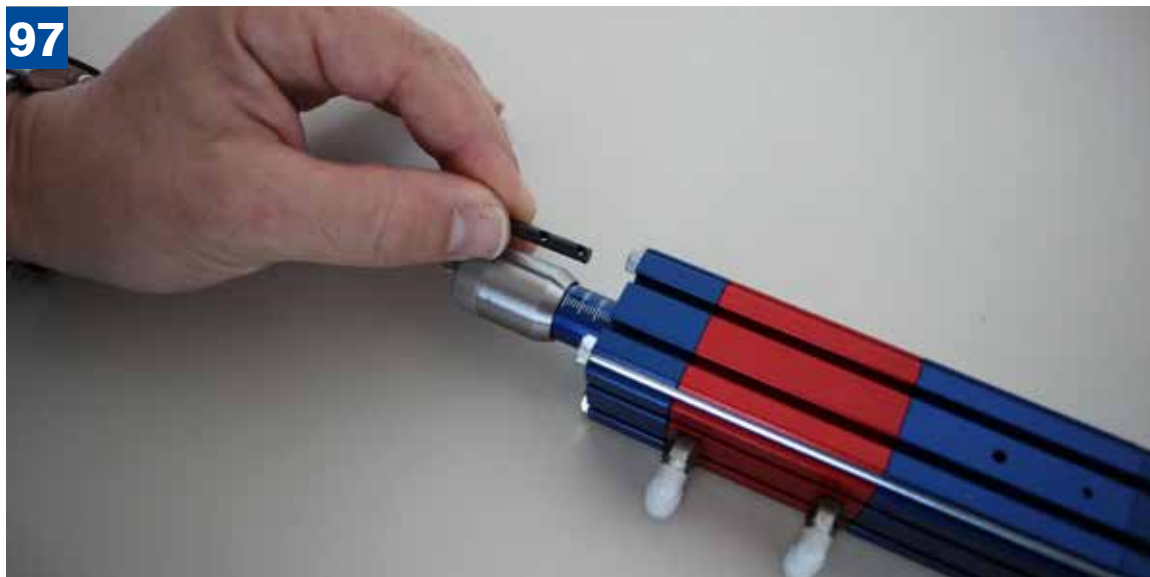

100

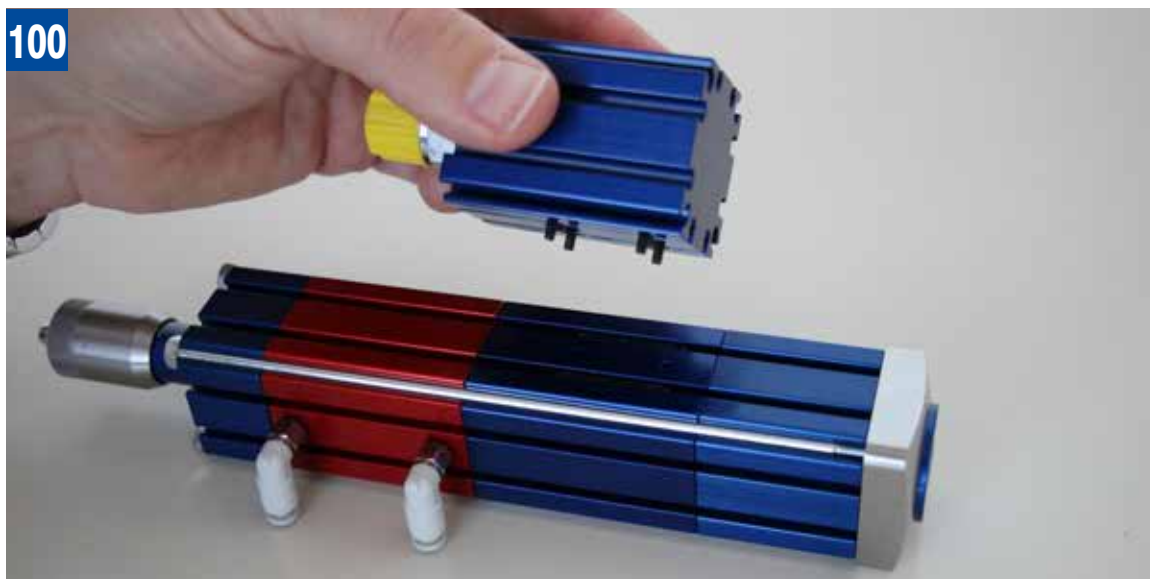

101

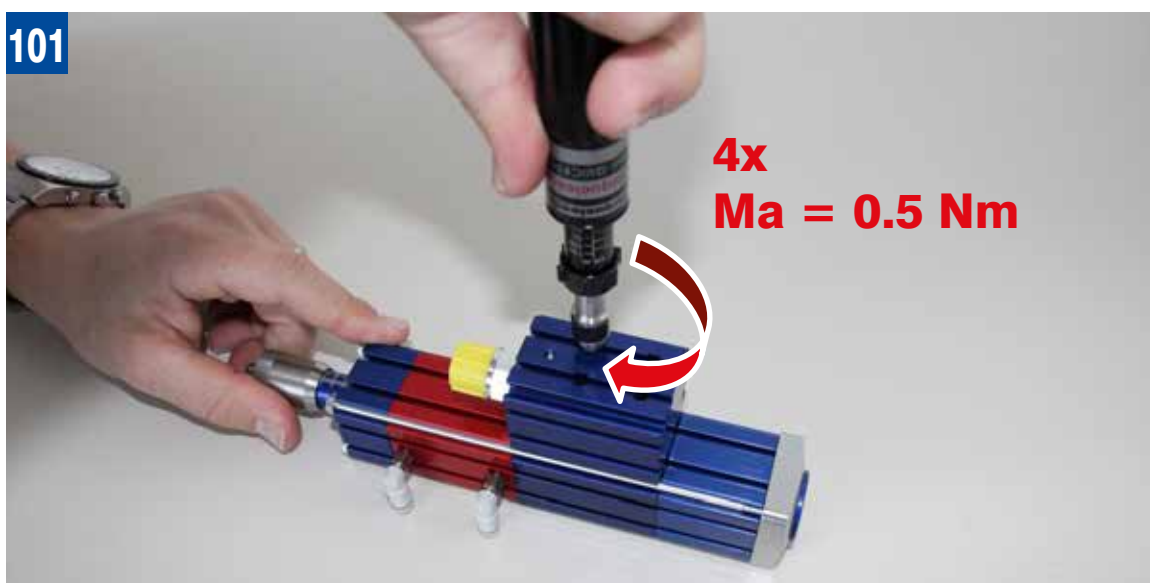

102

