

USE AND MAINTENANCE MANUAL

PROGRESSIVE CAVITY PUMP PCP-1500



Summary

1	GENERAL INFORMATION	1
1.1	SYMBOLGY	2
1.2	REFERENCE STANDARDS	3
1.3	DECLARATION OF INCORPORATION (ANNEX II B DIR. 2006/42/EC)	4
1.4	GLOSSARY	5
1.5	SERVICE AND MANUFACTURER CONTACT DETAILS	6
2	PRESENTATION AND OPERATION	7
2.1	EXPLODED	10
2.2	TECHNICAL DATA	13
3	SAFETY	15
3.1	MACHINE SAFETY DEVICES	16
3.2	FREE USEFUL SPACES	16
3.3	RISK AREAS AND RESIDUAL RISK	16
4	TRANSPORT AND HANDLING	16
5	INSTALLATION	17
5.1	POSITIONING	17
5.2	CONNECTIONS	18
5.2.1	Electric	18
5.2.2	Pneumatic	19
5.3	COMMISSIONING	22
6	SOFTWARE	22
7	PROCEDURE	23
7.1	AIR BUBBLE REMOVAL	23
7.2	STATOR INSTALLATION	24
7.3	PUMP WARM-UP	25
7.4	SYRINGE CHANGE	26
7.4.1	Standard method with viscosity less than 30,000 mPas	26
7.4.2	Standard method with high viscosities	27
7.4.3	Double syringe method	27
7.5	SYRINGE/CARTRIDGE REPLACEMENT	28
7.5.1	Syringe replacement	28
7.5.2	Cartridge replacement	29
8	MAINTENANCE	30
8.1	DISASSEMBLY AND REASSEMBLY OF THE PUMP	32
9	TROUBLESHOOTING	34
10	END OF LIFE	35

1 GENERAL INFORMATION

This manual contains information regarding the installation, use, maintenance and end of life of the component and provides indications for the most suitable behavior for correct operation. This manual has been designed to be simple and as straightforward as possible, with a subdivision into chapters and sub-chapters that allows you to find any information you need quickly. In addition, the manual begins by giving a general description of the contents, then an overview of the component, to arrive at aspects of safety, transport, installation and use and finally to the end of life. If you have any doubts about the interpretation or reading of this document, please contact the manufacturer.



DAV Tech declines any responsibility relating to improper use of the component. Observe the specifications in this manual.



Read this manual before handling the component or performing any action on it.



The manual is an essential safety requirement and must accompany the component throughout its life cycle.

It is the task of the end user to optimize the functionality of the component, always considering the purpose for which it was built.



You are asked to keep this manual, together with the attached documentation, in good condition, legible and complete. In addition, it must be stored in the vicinity of the component or, in any case, in a place accessible and known to all personnel who use the component itself or who must perform maintenance or inspection interventions. If the manual deteriorates or is no longer complete, a copy must be requested from the manufacturer, indicating the code of the manual and the revision.



The manual is intended for personnel who use the component (operators), who perform maintenance on it (maintenance technicians), and for personnel who must perform checks or inspections. The manufacturer is not liable for damage to the component caused by personnel who have not followed the instructions in the manual.

If you have any doubts about the correct interpretation of the information contained in this manual, please contact the manufacturer.

GUARANTEE

During the design phase, a careful choice of materials and components to be used in the project was made and they were subjected to regular testing before delivery. All elements have been designed and manufactured with an adequate degree of safety, such as to be able to withstand stress greater than those of normal use.

The warranty is valid for a period of 12 months from the date of commissioning and in any case no longer than 15 months from the date of delivery. Work carried out during the warranty period does not extend the warranty period in any way.

The manufacturer is not liable for defects due to normal wear and tear of parts which, by their nature, decay.

1.1 Symbology

Below are the symbols that are used to give a greater impact to the importance of the concept you want to give.



ATTENTION!

Refers to a warning that could lead to minor damage (minor injuries, damage to the component requiring maintenance work).



DANGER!

It refers to a major event that could cause major damage (death, permanent injury, irreversible breakage of the component).



NOTE. Indicate relevant information or insight.



OBLIGATION. It indicates a task that must be performed, related to both the component and the manual.



REFERENCE. Links to an external document that is important to view

In addition, the list of symbols is integrated with that of the personnel responsible for using the component and its function, together with other symbols used within the manual.



Operator

A (qualified) person capable of operating the component, adjusting, cleaning, starting or resetting the component. The operator is not authorized to perform maintenance.



Mechanical maintenance technician

Qualified technician able to carry out mechanical, adjustment, maintenance and routine repair work described in this manual. He is not authorized to carry out interventions on electrical systems in the presence of voltage.



Electrical maintenance technician

Qualified technician able to carry out electrical, adjustment, maintenance and routine repair work described in this manual. It can work in the presence of voltage on electrical cabinets and junction boxes. He is not authorized to carry out interventions on the mechanical side.



Manufacturer's technician

Qualified technician made available by the manufacturer to carry out operations of a complex nature in particular situations, or in any case as agreed with the customer.

1.2 Reference standards

The reference standards and directives of this manual are the following:

Directives

- 2006/42/EC – Machinery Directive;

1.3 Declaration of incorporation (Annex II B DIR. 2006/42/EC)

Manufacturer's name: DAV Tech Srl
Address: Via G. Ravizza, 30, .36075, Montecchio Maggiore (VI)

DECLARES THAT THE ALMOST MACHINE

Component: PCP-1500 Pump (Progressive Cavity Pump)
Model: Volumetric dosing pump
Year: 2024
Intended use: Volumetric dispensing of fluid to any viscosity

COMPLIES WITH THE INCORPORATION PROVISIONS OF DIRECTIVE 2006/42/EC

The technical documentation has been drawn up in accordance with Annex VII B, as required by the following:

- Machinery Directive 2006/42/EC of the European Parliament and Council of 17 May 2006

IT ALSO DECLARES THAT:

- Undertakings are undertaken to provide, in response to a properly substantiated request from the national authorities, relevant information on this partly completed machine;
- The technical file was prepared by Andrea Grazioli, via Ravizza, 30, Montecchio Maggiore (VI), IT.

This quasi-machine cannot be used until the machinery on which it will be used is declared compliant with regulation 2006/42/EC.

Montecchio Maggiore, 28 March 2024

The legal representative

Andrea Grazioli

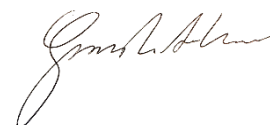

1.4 Glossary

The following are the most used terms within this manual with their meanings.

TERM	DEFINITION
Enable	Term that defines the act of preparing (enabling) an action. The action will be triggered as soon as the criteria are met, which consequently leads to the activation of the enabled action.
Active	The action that is performed instantaneously when the control is activated.
Human controls	This defines those commands that, used for manual operations, must be kept activated for the action to be performed. When the command is released, the action stops.
Two-hand controls	Human-controlled controls require two manual controls to be operated simultaneously to perform an action.
D.P.I.	Personal protective equipment. They include all the items necessary to ensure the protection of personnel from possible accidental damage (safety shoes, gloves, helmet, and more).
Display	It is used to display information. It can be in any shape and size, even touch screen.
Manufacturer	Natural or legal person who designed and manufactured the component covered by this manual.
HP	High Pressure. An acronym that indicates high pressure.
Icon	A small image that represents a command, a function or even a document or an operating program, which appears on a computer screen. When selected by the user, it initiates the function or program it symbolizes.
Joystick	Lever manipulator used in control panels.
N.A.	Not Applicable, i.e. it indicates that it is a field that does not apply to this manual and that it cannot be integrated into the component.
Operator panel	A control station where the machine control instruments are located
P.I.	Possible Implementation, i.e. it is currently absent from the component described in this manual, but it is possible to make an addition and implement it.
Screen	Interface system between man and component. Screenshots are the images displayed on the operator panel that allow the user to receive and provide information to the management software.
Push-button panel	Composition of buttons and selectors that allow you to act directly on the behavior of the component.
Keyboard	Keyboard only (stand-alone element) or in addition to a display (keys only, no selectors or other)
Touch screen	Touch screen that allows the user to interact with a graphic interface using their fingers or objects.

1.5 Service and manufacturer contact details

For any reason relating to the use, maintenance or request of spare parts, the customer must contact the manufacturer (or the service center if present) directly, specifying the identification data of the component.

The customer can make use of the technical and commercial support of local agents or importers, who are in direct contact with the company DAV Tech Srl.

Company name	DAV Tech Srl
Postal address	Via Ravizza, 30, 37065, Montecchio Maggiore (VI) – (IT)
Telephone	+39 0444 574510
Fax	+39 0444 574324
email	davtech@davtech.it
Website	www.davtech.it

2 PRESENTATION AND OPERATION

This component consists of a geared motor with an encoder and a progressive cavity auger. These two elements are closely related to each other, as the engine controls the auger, which carries the fluid forward for a number of revolutions controlled by the engine itself. The peculiarity of this component is the knowledge of the amount of fluid that is dosed for each revolution of the engine; therefore, by controlling the rotation of the auger you know exactly how much fluid is dispensed.

In other words, the function of this component is:

VOLUMETRIC DISPENSING OF FLUID TO ANY VISCOSITY

Intended use is the use described in the chapter below, while improper use is considered any other use that is not described in this manual, with products of different material and format from those for which it was built.

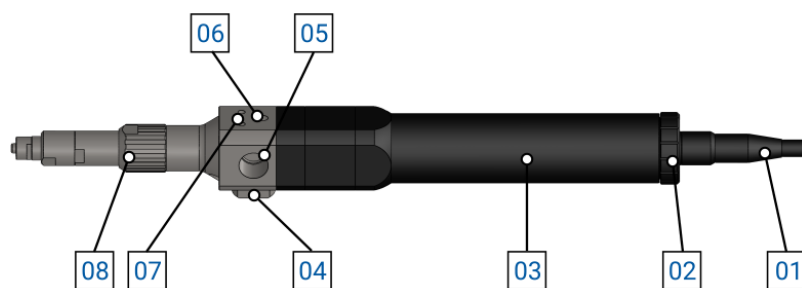

Figure 01 – PCP detail

No.	DESCRIPTION
01	Power cable
02	Electrical connection
03	Encoder motor chamber
04	Purge valve
05	Fluidic inlet
06	Fixing screw
07	Centering pin
08	Dosing area

OPERATION

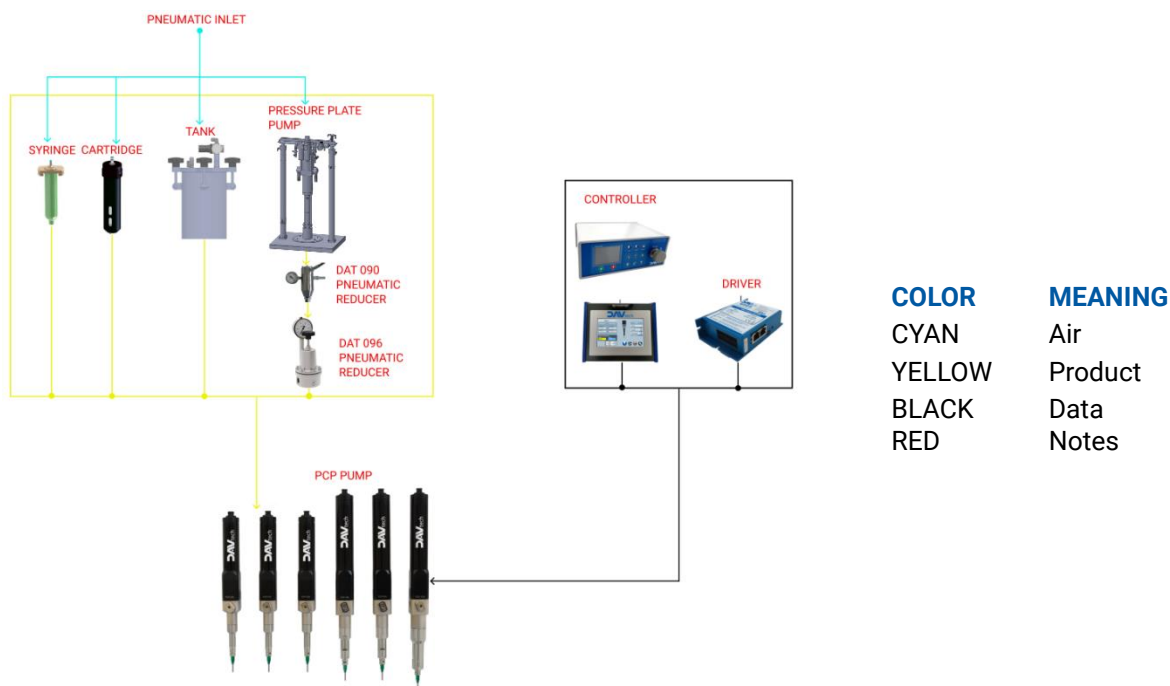

Figure 02 – Connection diagram

Figure 02 lists all the possible combinations with which a PCP pump of any size can be used. In particular, PCP pumps can be electrically connected to:

- PCP controller (EVO and BASIC), which has a simple and basic interface to be able to control the PCP. It features standard and minimum settings;
- PCP driver, which is controlled by a PLC that can be freely programmed, according to the customer's requests, and must be inserted inside the electrical panel.

In addition to electrical connections, it can have various fluidic connection combinations, namely:

- Syringe, which is a small container that allows it to be pressurized without the aid of external containers (it has an integrated connection);
- Cartridge, which is a small container, which needs an external tool to be pressurized (cartridge holder);
- Tank, medium-sized container that allows you to have both direct fluid and original container inside, according to applications and requests. There is also the ZIP configuration, which is a lid that is put on the drums to suck the fluid directly from the original drum;
- Pressure plate pump, a system that allows the fluid to be pressurized at high pressures, useful in the case of very viscous fluids. To be able to use it, it is necessary to series:
 - A DAT 090 fluidic pressure reducer/stabilizer, to switch from high to medium pressures;
 - A DAT 096 fluidic pressure reducer, to reach low pressures.

In addition, PCP pumps can be used in three working modes:

- Continuous dispensing (jog dispensing);
- Dispense a predefined volume (from dots to fills).

Based on the settings entered in the selected controller (controller or PLC).



ATTENTION!

It is recommended to connect the pump to the sources indicated in this manual in [chapter 2.2](#). Connecting it to other sources or products with features not listed in this manual may break the pump.

The amount of material is adjusted by:

- Dosing time;
- Motor speed adjustment.

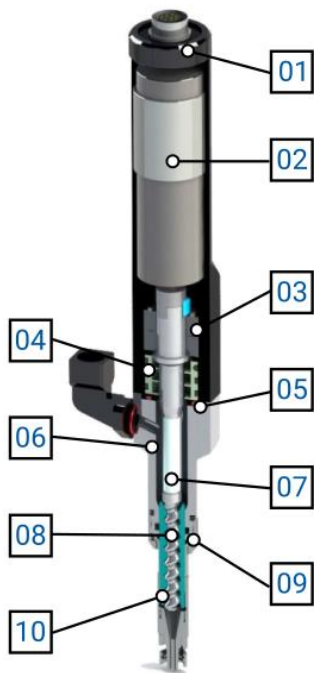

No. DESCRIPTION

01	Closing
02	Gear motor with encoder
03	Bearing block
04	Gasket lock
05	O-Ring FKM
06	Fluidic chamber
07	Eccentric joint
08	Rotor
09	Ring
10	Stator

Figure 03 – PCP Section

The progressive cavity pump is a positive displacement pump that can deliver a constant amount of fluid, regardless of its viscosity. In addition, the advantage of this pump is that it combines the performance of a volumetric valve (for example, a DAV, for precise dosing) and a pressure/time valve (for example, a DA 400, for dosing beads) in a single instrument. Furthermore, it does not need a pneumatic system to be controlled, but only an electrical connection, to control the gearmotor, and the fluidic connection, to allow the entry of the fluid itself. To keep the engine safe from the fluid there is a gasket block. The rotation of the gear motor, which controls the rotation of the rotor and, therefore, the dispensing of the fluid, can be controlled directly from the controller, or from the PLC (depending on the setting chosen).

In addition to these features, the progressive cavity pump is also equipped with the possibility of sucking the product, which avoids the formation of the classic fluid drop when the dispensing ends (due to the residual pressure). This is possible thanks to the reverse rotation of the geared motor, which causes the rotor to rotate in reverse and generates a vacuum that brings the fluid back.



ATTENTION!

While the pump is running, there must always be fluid entering from the pump inlet. Leaving the pump to run without fluid leads it to overheat and, therefore, to be damaged.

USEFUL TIPS

- Choosing the best nozzle for your application should be evaluated based on the amount of fluid to be dispensed and the desired application outcome. If in doubt, ask the manufacturer;

2.1 Exploded

A list of the main pump components with spare parts is shown below.

PCP 1500

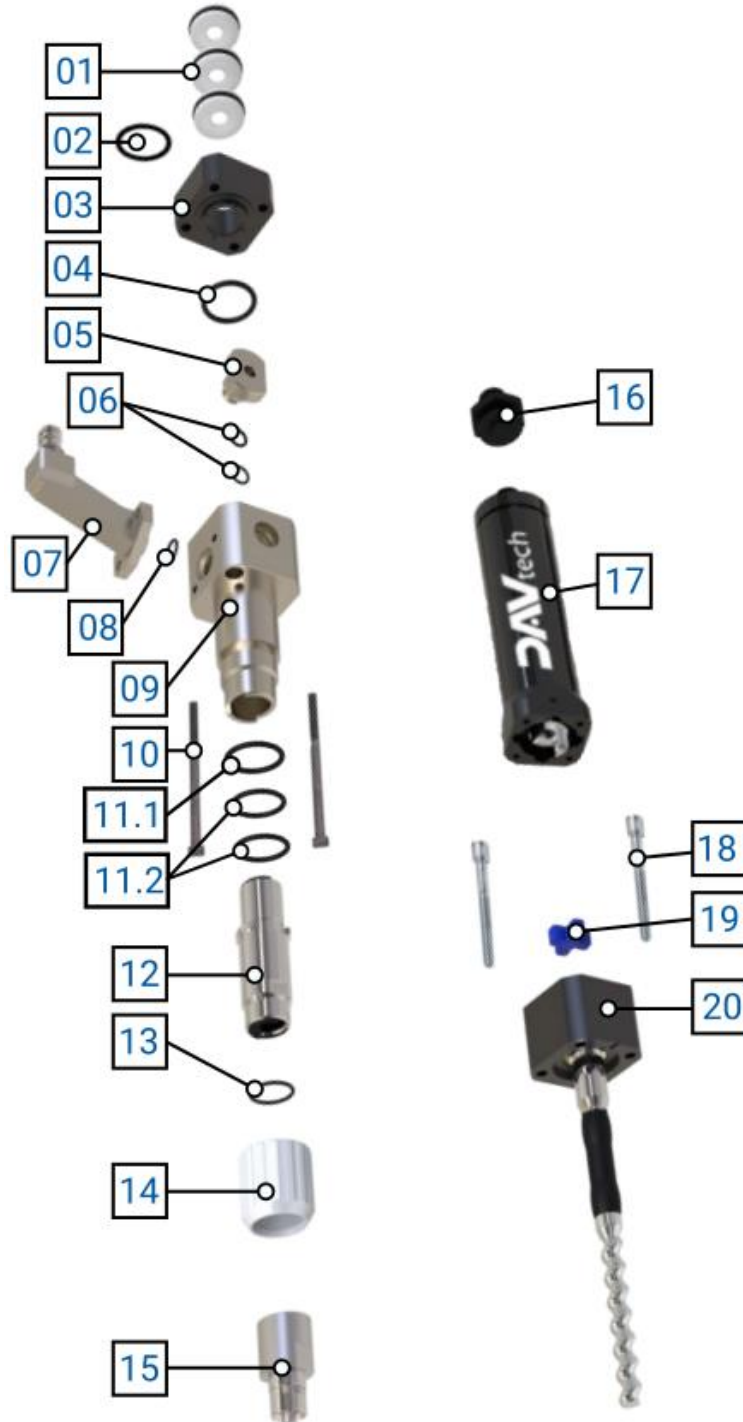

No.	Description	Var.	Code	Variant details
01	ROTARY SEAL FOR PCP (x1 pcs)	-	PCP-ROTARYSEAL	-
02	O-RING FKM (X1 pcs)	-	-	-
-	-	02.a	PCP-F	-
-	-	02.b	PCP-F-FFKM	-
03	LARGE PCP SEAL BODY	-	PCP-SEALBLOCK-B	-
04	O-RING FKM	-	PCP-E	-
05	PCP PURGE VALVE	-	-	-
-	-	05.a	PCP-PURGE	PCP MANUAL PURGE VALVE
-	-	05.b	PCP-PURGE-UV	PCP MANUAL PURGE VALVE FOR UV
06	O-RING FKM (X1 pcs)	-	PCP-D	-
07	LARGE MODULE ADAPTER FOR PCPM	-	-	-
-	-	07.a	PCPM-SYRINGE3055CC-B	LARGE PCP MODULE ADAPTER FOR 30CC SYRINGE
-	-	07.b	PCPM-310-B	LARGE PCP CARTRIDGE MODULE ADAPTER 310CC
-	-	07.c	PCPM-SEMCO-B	SEMCO 60Z PCP LARGE MODULE ADAPTER
08	O-RING FKM	-	PCP-C	-
09	LARGE POMP BODY PCP/PCPM	-	-	-
-	-	09.a	PCP-BODY-1000	STANDARD THREADED LARGE BODY
-	-	09.b	PCPM-BODY-1000	LARGE BODY FOR MODULE
-	-	09.c	PCPM-BODY-1000-PEEK	LARGE BODY FOR PEEK MODULE
10	SCREWS (X2 pcs)	-	PCP-3	-
11.1	O-RING FKM	-	PCP-M	-
11.2	O-RING FKM (X1 pcs)	-	PCP-L	-
12	STATOR ASSEMBLY	-	-	-
-	-	12.a	PCP-1500-STATOR-	STATOR ASSEMBLY FFKM
-	-	12.b	PCP-1500-STATOR-EP	EPDM STATOR ASSEMBLY
-	-	12.c	PCP-1500-STATOR-FE	FEPM STATOR ASSEMBLY
13	O-RING FKM	-	PCP-I	-
14	LARGE PCP RING NUT	-	PCP-NUT-1000	-
15	PCP LARGE ENDING	-	-	-
-	-	15.a	PCP-LUER-1000	LARGE PCP LUER LOCK ADAPTER
-	-	15.b	PCP-14-1000	1/4" LARGE PCP ADAPTER
-	-	15.c	PCP-LUER-1000-PEEK	LARGE PCP PEEK LUER LOCK ADAPTER
16	PCP LARGE MOTOR CONNECTOR	-	PCP-CONNECTOR-B	-
17	LARGE PCP ENGINE ASSEMBLY (including component 16)	-	PCP-MOTOR-B	-
18	SCREWS (X2 pcs)	-	PCP-2	-
19	ELASTOMER LARGE PCP MOTOR COUPLING	-	PCP-JOINT-B	-
20	ROTOR ASSEMBLY (including component 19)	-	-	-
-	-	20.a	PCP-1500-ROTOR	STAINLESS STEEL ROTOR ASSEMBLY PCP-1500
-	-	20.b	PCP-1500-ROTOR-TC	CARBIDE ROTOR ASSEMBLY PCP-1500
-	-	20.c	PCP-1500-ROTOR-ZC	PCP-1500 CERAMIC ROTOR ASSEMBLY
-	KIT O-RING	-	GASKETKIT-PCP1000	-

OTHER GENERAL COMPONENTS

Description	Code	Image
PCP PRESSURE SENSOR - PDP	PCP-PRESSURESENSOR	
2 METER PCP MOTOR CABLE	CABLEPCP-2MT	
7 METER PCP MOTOR CABLE	CABLEPCP-7M	
10 METER PCP MOTOR CABLE	CABLEPCP-10MT	
CONTROLLER BASIC PER PCP	CONTROLLER-PCP	
CONTROLLER EVO PER PCP	CONTROLLER-PCP-EVO	
PROFINET PCP / MODBUS PCP DRIVE	DRIVE-PCP-PROFINET	
	DRIVE-PCP-MODBUS	
	DRIVE-CONTROLLER-PCP-EVO	
PCP DISASSEMBLY KEY	PCP-TOOL-S	
	PCP-TOOL-B	
	PCP-TOOL-1000	
STATOR DISASSEMBLY TOOL	PCP-TOOLMOTOR-S	
	PCP-TOOLMOTOR-B	
ADDITIONAL MODULE FOR PRESSURE SENSOR	PCP-PRESSUREOUTLET-S	
	PCP-PRESSUREOUTLET-B	
	PCP-PRESSUREOUTLET-1000	

2.2 Technical data

All the technical characteristics concerning the component of this manual are indicated below.

SPECIFICATIONS		
Description	UdM	Values
Activation	\	Controller o Driver
Maximum fluid pressure	bar	0 - 6
Maximum dosage pressure	bar	12
Dosing volume per round	cc	1.1
Dosage accuracy		±1%
Motor speed	Rpm	1 ~ 120
Fluid inlet thread	\	1/4" GAS
Fluid outlet thread	\	Luer Lock 1/4"
Materials used	\	AISI 304
		AL
		UHMW-PE
		FFKM (stator)
		FKM

ENVIRONMENTAL CHARACTERISTICS		
Description	UdM	Values
Working Ambient Temperature	°C	10 ÷ 40
Storage Ambient Temperature	°C	-20 ÷ 55
Permissible non-condensing humidity	%	10 ÷ 85

USABLE FLUIDS		
Silicones		
Liquid gaskets		
Grease		
Resins		
Miscellaneous products with viscosity between 1 and 1,000,000 cPs		

DIMENSIONAL AND WEIGHT CHARACTERISTICS

Description	UdM	Value
Component length (min ÷ max)	mm	312
Component depth (min ÷ max)	mm	29
Component diameter (min ÷ max)	mm	29
Component weight	kg	0.7

Component

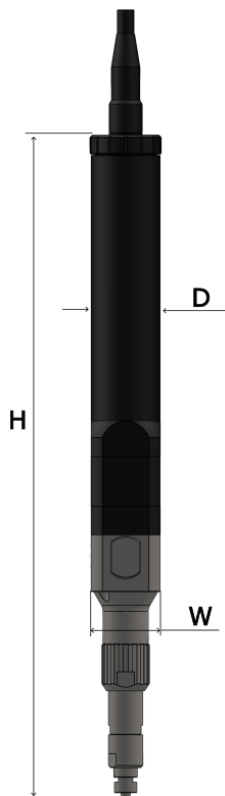

You can request the 3D of the component in the desired version from the manufacturer without any obligation.

3 SAFETY

The following is a list of warnings regarding the component covered by this manual. Please read carefully before proceeding to the next chapters.



DANGER!

Before operating the component or performing any action on it, read this manual carefully.



DANGER!

Do not use the component while under the influence of drugs or other substances that may impair attention and reaction ability.



DANGER!

Operators must only perform operations or interventions that are within the competence of the role and qualification assigned.



FIRE/EXPLOSION HAZARD!

This component is not designed to work in an ATEX environment.



DANGER!

Be very careful when servicing the component, especially when disassembling components that have spring under pressure inside.



ATTENTION!

Modifications to the component must not be made to achieve performance other than that for which it was designed and built, unless authorized by the manufacturer.



ATTENTION!

Avoid introducing foreign bodies, even small ones, into the pneumatic system, which could cause the system to malfunction and compromise the safety of the machine.



The component may only be used by trained and authorized operators and for the sole purpose for which it was designed and manufactured.



The component is manufactured in compliance with the technical safety standards in force at the time of its construction.

3.1 Machine safety devices

N.A.

3.2 Free useful spaces

N.A.

3.3 Risk areas and residual risk

N.A.

4 TRANSPORT AND HANDLING

Once you have received the goods, you must check that the packaging is intact and that there is an exact correspondence with the material ordered.



ATTENTION!

The original configuration of the component must not be changed. The manufacturer is not liable for damage caused by inappropriate use of the component.



ATTENTION!

If the packaging is not intact, contact the manufacturer immediately, also sending photos of the condition of the packaging. Do not open it until you have notified the manufacturer.

5 INSTALLATION



The installation of the component is carried out by the customer. If necessary, you can contact the manufacturer to have a specialist technician to help you.

The pump has been designed to be used in the following cases:

- Works independently to dose the fluid in a volumetric way.

It is also equipped with a screw housing (number 06, figure 01, [chapter 2](#)) and two housing for centering pins (number 07, figure 01, [chapter 2](#)) for perfect centering both during installation and after maintenance. It is also advisable to fix it well to the support, as the vibrations that are caused by the machinery in operation could take the pump off-center, resulting in a dosage that is not optimal.



It is recommended that you perform a component check before beginning the installation. If it is evidently damaged, please contact the manufacturer.



ATTENTION!

Please remove the packaging with the utmost care. If damage is caused to the component, the manufacturer is not liable.



Dispose of the packaging correctly, considering the different nature of the components and following the regulations in force in the country.

5.1 Positioning







N.A.

5.2 Connections

In this chapter, we want to explain the connection method that must be used for the component. The following types of connection are provided:

- Electrical connection;

5.2.1 Electric

Authorized personnel	 PPE to wear     
Component status	Component installed
Power Values	See chapter 2.2
Necessary preparations	Working electrical system
Materials needed	\
Equipment needed	Wrench or screwdriver



The electricity connection is at the expense of the customer.

For this type of pump, there is an electrical installation that concerns the power supply of the gear motor, in which the cable must be connected to the controller, or to the driver. In any case, follow the instructions in the respective manuals (controller or driver).

5.2.2 Pneumatic

Authorized personnel	PPE
Component status	Placed on working position
Power supply values	See chapter 2.2
Necessary arrangements	Working pneumatic air system
Material needed	N.A.
Equipment needed	N.A.



The pneumatic connection is charged to the Customer.

The PCP pump does not require pneumatic connections; however, if a cartridge or syringe is used for pneumatic feeding, the cartridge (or syringe) must be connected to the pump in order to transport fluid from the cartridge (or syringe).

WARNING!



Both the cartridge and the syringe must have an inlet pneumatic pressure reducer to limit the pressure to 2 - 3 bar, otherwise air will infiltrate between the pad and the cartridge itself, affecting the dosage; or the walls of the syringe or cartridge may be damaged by excessive pressure.

In general, there are the following components that can be used:

SYRINGE ADAPTER (Component 07.a e 07.b [chapter 2.1](#))

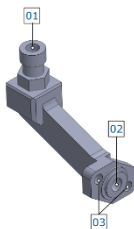

Component used to connect the syringes to the PCP pump. Point 01 has a luer-lock thread and is where the syringe is connected; point 02 is where the fluid comes out to enter the PCP pump, while points 03 are through holes to connect the adapter to the pump. There can be different sizes, depending on the size of the pump itself.

QUICK CARTRIDGE ADAPTER (Component 07.c [chapter 2.1](#))

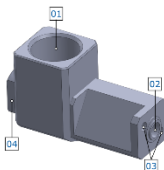

Component used to connect the cartridge holders to the PCP pump. There are both small and large, depending on the size of the pump itself. Point 01 is the quick-release connection for the cartridge holder, which changes according to the type of cartridge thread; point 02 is where the fluid comes out to enter the PCP pump; points 03 are through holes to connect the adapter to the pump; Point 04 is used to purge the fluid during cartridge change

ADAPTER CARTRIDGES SEMCO (Component 07.d [chapter 2.1](#))

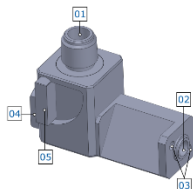

Component used to connect the cartridge holders to the PCP pump. There are both small and large, depending on the size of the pump itself. Point 01 is the interface nipple between cartridge and adapter; point 02 is where the fluid comes out to enter the PCP pump; points 03 are through holes to connect the adapter to the pump; Point 04 is used to purge the fluid when changing the cartridge; Point 05 is used to lock the nipple in position.

SYRINGE

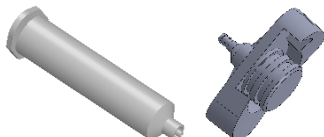

They are small components that contain fluid in their interior. They can be attached directly to the adapter and, through a special connection, you can connect the air, which pushes a buffer towards the fluid to make it go to the pump.

CATRIDGES

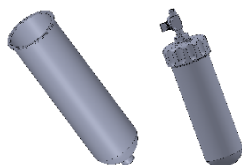

They are components that contain fluid in their interior, of various sizes. To be used, they must be combined with cartridge holders, which have the pneumatic connection to pressurise the pad inside, extruding the product towards the pump. On the cartridge holder there is a two-way pneumatic valve at the inlet.

CONNECTION PCP TO SYRINGE

To connect a PCP to a syringe, you must:

- Place the syringe adapter in the fluidic inlet and screw it into place with the appropriate screws;
- Insert the plunger inside the syringe, if it is not already present;



With low viscosity fluids, no buffer is required

- Attach the syringe to the syringe holder described above, screwing it on until it offers some resistance;
- Connect the cap to the syringe by rotating it about 90°;
- Connect the pneumatic tube to the syringe cap;
- Bring the syringe's pneumatic pressure reducer to zero;
- Open the air;
- Adjust the pressure reducer to a maximum of 2 - 3 bar. The pressure indicated here must not be exceeded.

CONNECTION OF PCP TO CARTRIDGE HOLDERS

To connect a PCP to a cartridge holder, you must:

- Place the cartridge adapter in the fluidic inlet and screw it into place with the appropriate screws;
- Screw the appropriate adapter onto the cartridge, whether it is a Teflon adapter ([07.c](#)) or a PEEK nipple ([07.d](#));
- Insert the cartridge into the cartridge holder and check that the adapter is correctly positioned;
- If you are using the PEEK adapter ([07.d](#)), close the lock 05
- Connect the pneumatic hose, keeping the inlet valve closed;
- Bring the pressure reducer to 0 bar;
- Open the air;
- Bring the pressure reducer between 2 and 3 bar. The pressure indicated here must not be exceeded.

5.3 Commissioning

The commissioning of the component is carried out once the positioning and connection of the connections has been completed. Before commissioning the component, the following checks must be carried out:

- Check that the connections have been connected correctly;
- Check that the component is free of dirt or residues of various kinds;



ATTENTION!

If even one of the above points does not comply, commissioning must not be carried out. Commissioning should only be carried out when all points have been successfully completed.

6 SOFTWARE

N.A.

7 PROCEDURE

In this chapter we want to explain the main configurations that can be used on the component covered by this manual. We want to explain in detail:

- How to remove air bubbles before dispensing fluid
- How to perform stator-rotor installation for the first time, or in case of maintenance;
- How to warm up the pump after a prolonged standstill.

7.1 Air bubble removal

When the pump installation phase is finished, before feeding the fluid to the pump, you must:

- Insert a $\varnothing 4 \times 2.5$ mm hose inside the hole of the purge valve (recommended);
- rotate the vent valve (D) following the direction of the arrow
- Putting pressure on the system;
- Close the valve once any air bubbles and some fluid have been drained (for about 5 – 10 seconds), until the fluid comes out evenly.
- Close the valve;
- Remove the hose;
- Clean the area carefully;



To preserve the functionality of the valve, it is recommended to put petroleum jelly grease inside the hole where the tube is placed.



ATTENTION!

When eliminating air bubbles, you should set a low motor speed to discharge them (5 ÷ 10 rpm).

- Dose a little product until you get a constant output.



7.2 Stator Installation

If you need to change your stator, you must follow the instructions below for installation.



ATTENTION!

Not doing what is written below can lead to damage to the stator, even if you activate the rotor for a very short time

You must use component C to block the rotor and apply a layer of fluid that you want to dispense on the rotor itself (if there are no contamination problems, it is advisable to also use petroleum jelly oil or common grease instead of the original product). Once some product has been distributed, the stator (A) must be engaged on the rotor (B) and rotated clockwise (using tool C) until the fins circled in the drawing correspond with the indicated seats.

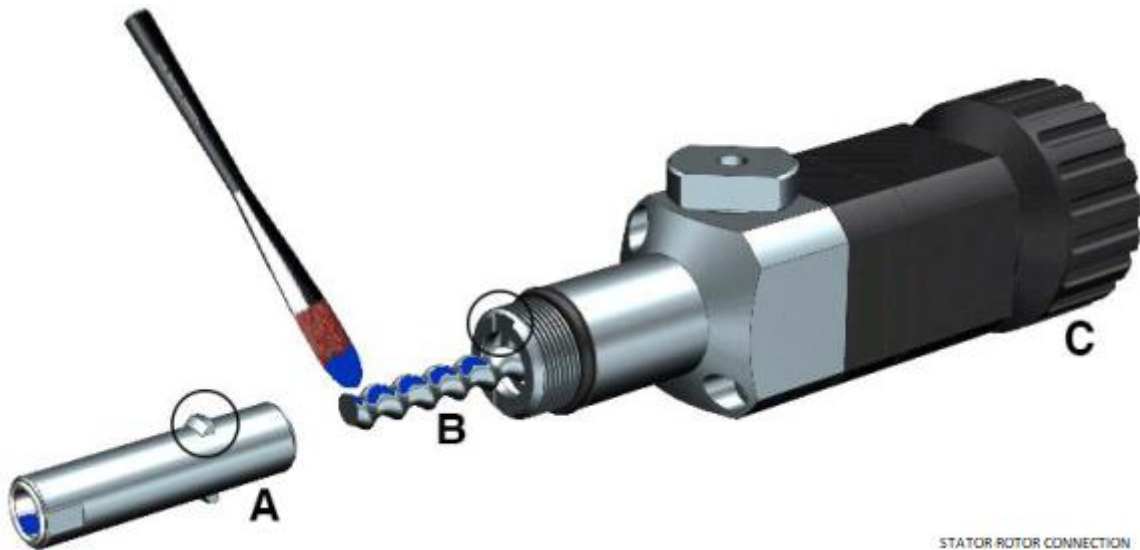

7.3 Pump warm-up

This procedure is recommended with any type of fluid and is used to prevent the stator from being damaged by starting too quickly, i.e. after a prolonged stoppage a phenomenon called "surface adhesion" tends to occur, in which the stator and rotor tend to stick together due to the fluid that is present between them. If the pump starts at nominal working flows, there is a risk of tearing the stator due to this adhesion force, ruining the stator itself.

To avoid this, you can set a warm-up phase of the pump by making the rotor move slowly. In this case, there are two possible methods:

- If the pump has been tested by the manufacturer and the system sold also includes software (whether PLC or controller), a heating recipe is already present; just select it and start it every time you have a prolonged stop;
- If the pump is sold as stand-alone, a heating function must be created using the following parameters. Attention, the parameters depend on the viscosity of the fluid itself:
 - Equivalent volume of fluid to be released
 - at the nominal flow rate of the pump for viscosity > 200 mPas;
 - at 5 times the nominal flow rate of the pump for viscosity ≤ 200 mPas;
 - Flow rate to be set equivalent to 5% of the pump's rated flow rate for any viscosity;
 - Times after which to perform this procedure:
 - For viscosity > 200 mPas, it is recommended to run it after every 8 hours downtime;
 - For viscosity ≤ 200 mPas (or for special cases agreed with the constructor) it is recommended to run it after half an hour downtime.

The nominal flow rate is given in [section 2.2](#) as "Dosing volume per round".

7.4 Syringe change

Changing the syringe is the most delicate phase of using this system, as it is important to avoid air bubbles inside the syringe itself, which could change the quality of the dosage itself. To be able to change the syringe, three methods can be followed:

- Standard method with fluids that have viscosity less than 30,000 mPas;
- Standard method with fluids that have high viscosities;
- Double syringe method.

The choice of method is left to the customer, based on the equipment available.



ATTENTION!

Using the first method with fluids that have a viscosity greater than 30,000 mPas may give unsatisfactory results and cause bubbles to remain inside the syringe.

7.4.1 Standard method with viscosity less than 30,000 mPas

- Insert the metal pad inside the plunger. The smooth part of the metal pad should serve as a base for the plunger



ATTENTION!

There are different pads and plungers on the market, depending on the model. Please follow the standard models recommended by the manufacturer

- Take a new syringe (with a cap on the nozzle side) and, holding it with the nozzle side down, fill it to about 3/4 of fluid;



ATTENTION!

In the case of glue-like fluids, it is advisable not to dirty the side walls, as they then solidify and block the plunger, making the syringe ineffective

- Insert the plunger and buffer assembly inside, taking care to put the plunger on the side of the fluid;
- Once the plunger is inserted as close as possible, turn the syringe 180°, bringing the nozzle part upwards;
- By physical separation, the air is directed towards the nozzle, while the fluid approaches the plunger;
- Once the air is all towards the nozzle, remove the cap and push the plunger until a tip of fluid comes out;
- Clean the nozzle, insert the nozzle and the nanopen hook;
- The nanopen piston is put into rest mode using the appropriate button (No. 06 [chapter 6.1](#)) and the syringe is inserted into the syringe slot.

7.4.2 Standard method with high viscosities

- Insert the metal pad inside the plunger. The smooth part of the metal pad should serve as a base for the plunger

**ATTENTION!**

There are different pads and plungers on the market, depending on the model. Please follow the standard models recommended by the manufacturer

- Take a new syringe (with a cap on the nozzle side) and, holding it with the nozzle side down, fill it to about 3/4 of fluid;

**ATTENTION!**

In the case of glue-like fluids, it is advisable not to dirty the side walls, as they then solidify and block the plunger, making the syringe ineffective

- Insert the plunger and buffer assembly inside, taking care to put the plunger on the side of the fluid;
- Place the syringe on a fluid separation device (centrifuge, vibrating plate, or other) and wait for the air and fluid to separate, with the fluid towards the plunger and the air towards the nozzle;
- Open the nozzle cap and let out all the air inside the syringe by pushing through the plunger until a tip of fluid comes out;
- Clean the nozzle, insert the nozzle and the nanopen hook;
- The nanopen piston is put into rest mode using the appropriate button (No. 06 [chapter 6.1](#)) and the syringe is inserted into the syringe slot.

7.4.3 Double syringe method

- Insert the metal pad inside the plunger. The smooth part of the metal pad should serve as a base for the plunger

**ATTENTION!**

There are different pads and plungers on the market, depending on the model. Please follow the standard models recommended by the manufacturer

- Take a new syringe and one with the fluid and, using a special fitting, join the two cartridges;
- Insert the plunger inside the new syringe (in the one with the fluid there should already be the plunger)
- Pushing through the plunger of the filled syringe and keeping the empty syringe pressurized, push the fluid into the new syringe;
- Remove the now empty syringe and the fitting and put the appropriate nozzle;
- Insert the nanopen hook;
- The nanopen piston is put into rest mode using the appropriate button (No. 06 [chapter 6.1](#)) and the syringe is inserted into the syringe slot.

7.5 Syringe/cartridge replacement

This procedure is used to explain how to change a cartridge or syringe in the correct way, which is to be carried out when the cartridge (or syringe) is empty, or, if a level sensor is present, if a level alarm signal has been sent to the control system of the dosing plant.

7.5.1 Syringe replacement

To change the syringe, you must:

- Reduce the pneumatic pressure entering the syringe to zero using a pressure gauge. If there is a two-way valve between the pressure gauge and the syringe, it can be closed instead of removing the pressure;



ATTENTION!

Removing the pneumatic pressure via a pressure gauge or valve should also remove the residual air, depending on the type of component used.

- Rotate the syringe's pneumatic connection 90° so that it can be removed from its position. If the internal pneumatic pressure has not been removed, it is advisable to hold it firmly until it completely relieves the pressure during removal;
- Turn the syringe counterclockwise to remove it from its position;
- Insert a new syringe by turning clockwise;
- Attach the pneumatic connection of the syringe to reinsert it in position;
- Turn the two-way valve (if you used that), or repressure the pressure gauge to a maximum of 3 bar.

7.5.2 Cartridge replacement

There are two types of cartridge adapters, each with its own procedure. Below is how to perform the cartridge change for both cases:

SEMCO ADAPTER (07.d)

- Reduce the pneumatic pressure entering the syringe to zero using a pressure gauge. If there is a two-way valve between the pressure gauge and the syringe, it can be closed instead of removing the pressure;



ATTENTION!

Removing the pneumatic pressure via a pressure gauge or valve should also remove the residual air, depending on the type of component used.

- Unscrew the cap on the cartridge holder. If the pneumatic pressure has not been removed, there may be a vent due to the air inside the cartridge
- Turn the lever so that the cartridge is unlocked
- Remove the cartridge from its housing
- Remove the adapter from the cartridge and clean it thoroughly
- Open a new cartridge and insert the adapter into the new cartridge
- Insert the cartridge into the cartridge holder and the adapter into its housing, making sure that the coupling on the adapter must face the opposite side of the PCP pump
- Close the cartridge lock hook
- Close the cartridge holder cap
- Open the bleed valve next to the adapter (No.04 [chapter 5.2.2](#)). Just rotate half a turn to get the fluid out of that area
- Restore air to the system, either through the two-way valve or via a pressure gauge
- Allow all air to be purged. When you see that fluid begins to come out, close it and clean it



ATTENTION!

The valve must be closed manually and not with a key, otherwise the wall will be deformed, making the component compromised and no longer able to do its job

- If it has not already been done, bring the pneumatic pressure to the working value (maximum 3 bar)

QUICK ADAPTER (07.c)

- Insert the cartridge into the cartridge holder and the adapter into its housing, making sure that the adapter is in the rebate

8 MAINTENANCE

Maintenance interventions are all those activities that must be performed on the component which, if carried out correctly, allows it to have a longer life. In general, maintenance is divided into two groups:

- **Ordinary maintenance**, which are interventions on a regular basis or that can be carried out by the customer's staff, are the most important activities as they allow the component to be kept in good working condition;



ATTENTION!

Ordinary maintenance must be carried out in the manner and timing indicated in the following chapters.

- **Extraordinary maintenance**, i.e. all those interventions that are not regularly carried out or that have not been planned, or interventions that cannot be carried out by the Customer. They can also arise from the lack of routine maintenance.



ATTENTION!

Extraordinary maintenance work must be carried out together with the manufacturer's specialized technicians.



Regarding attendance, it must be considered that:

- **When necessary**: Operation to be carried out when the need to be carried out is seen;
- **Every component start or job end**: Indicates a daily time period, in general. This can imply every 24 hours (i.e. at the beginning of the shift of every day, or the end of the shift of every day), or even more frequently, depending on the application;
- **Long pause**: Indicates a period approximately greater than an hour;
- **Each drum change**: Indicates each time the fuel system (tank, drum, cartridge or other) is changed;
- **Each mixer disassembly**: Indicates that each time the mixer is replaced, a certain operation must be performed;
- **Weekly**: Indicates a period equal to seven calendar days;
- **Monthly**: Indicates a period equal to one calendar month;
- **Semi-annual**: Indicates a period equal to six calendar months;
- **Yearly**: Indicates a period equal to one calendar year.



ATTENTION!

The times given below are indicative as they depend on how the component is used. Follow the variations suggested by the technicians.

Assigned	Description	Frequency	Chapter
	Perform a test run on the pump (check that the purge makes a constant flow of product)	occasional	\
	Perform a surface cleaning of the pump	daily	\
	Check if the components are correctly fastened (screws and others)	weekly	\
	Disassembly and reassembly of the pump	annual	8.1



ATTENTION!

Only use soft brushes or cotton cloths to clean the pump.



ATTENTION!

Do not perform insulation tests on the component, as it may cause malfunctions on the component itself.



ATTENTION!

Remove power whenever maintenance is performed on the component itself, as incorrect sensor readings could cause the component to start, damaging it or injuring the people working on the component.

8.1 Disassembly and reassembly of the pump

Assigned	Periodicity	Materials and equipment
	annual	<ul style="list-style-type: none"> • 2.5mm hex wrench; • Open-end wrench provided; • Unscrewing tool provided; • Slotted screwdriver; • Generic Bearing Grease

PPE to wear



Below we want to explain how to disassemble and reassemble the PCP pump in all its models. For a video guide, please refer to the [following link](#)

01

N.A.

Unscrew the purge valve and store it on one side;

02



Unscrew the screws that hold the pump body together with the gear motor using the 2.5mm hex wrench.



In the case of the PCP-1000, it is recommended to remove the nut first and then the screws, otherwise you risk ruining the pump body

03



Using the open-ended wrench provided, remove the luer lock adapter (A) or equivalent and store it on one side. Once removed, remove the nut (B) using the same open-end wrench and, if present, remove the stator sleeve

04



Using the stator unscrewing tool provided, place it on the rotor at the beginning of the pump and turn it counterclockwise to unscrew the stator and separate the two components.



If the operation is complicated, it is possible to hold the stator with a special wrench and rotate the rotor after removing the screws

05



Use the hex wrench to remove the screws that hold the seal block and pump housing together and remove the pump body.

06

Remove the seal block from the rotor block by making small rotations of the seal block clockwise and counterclockwise and pulling the seal body. Once removed, remove the seals inside using a small flathead screwdriver.

N.A.



ATTENTION!

It is important to remember the order in which the seals were removed as they must be reassembled in the same order afterwards.



ATTENTION!

If the seals are damaged or deformed, they must be replaced and, if not all of them are replaced, the newer ones must be positioned towards the engine.

MOUNTING NOTES

- Before putting the seals back in place, grease the o-rings of the seals themselves by spreading it well over the entire seal;
- Before fitting the seal block to the rotor shaft, grease the area where the block rests;



ATTENTION!

While mounting the seal block, the "U" recess on the seal block must be matched with the pump model lettering.



- Once the pump body has been screwed on, before putting the stator back on, the rotor must be greased over the entire helical area;
- When screwing the stator into place, care must be taken that the stator must be positioned in its correct seat, as indicated in [chapter 7.1](#)

9 TROUBLESHOOTING

This chapter deals with the most common problems that may arise when using the component of this manual.

ATTENTION!

Once the operator has found a problem or assumes that there is a problem, they must call the technician in charge of maintenance. Maintenance should always be performed by a specialized and qualified technician.

DEFECT	CAUSE	SOLUTION
Does not carry out the dosage	Lack of input fluid	Check the fluid supply
	No power	Check the power supply to the controller/plc
	Clogged nozzle	Check if the nozzle is blocked
	Possible problems with the geared motor	Check that the engine is working properly
Changing the dosed volume	Possible incorrect software parameters	Check if the controller/plc parameters have changed
	Fluidic problems	Check that there are no solid blockages of fluid in the chamber
		Check that the nozzle is clear of obstructions
		Check for air bubbles
		Check that the tank pressurization air is as specified
Check for fluid leaks		
Fluid that continues to come out of the nozzle after dosing is complete	Worn seals	Check the seals
	Fluidic inlet pressure too high	Check if the pressure is within the range given in chapter 2.2
	Damaged stator	Perform warm-up and possibly overhaul the pump
The pump doses autonomously	Possible damage to the motor connector	Check the condition of the cable and connector
Pump motor does not turn	Possible incorrect software parameters	Check the parameters you set
	Possible damage to the motor connector	Check the engine connections Check if there is power
	Possible hardening of the product	Check if the fluid has solidified inside the chamber
Fluid comes out of the pump body	Worn seals	Overhaul the pump
	Worn bearings	Check the o-rings of the seal body
Check rotor bearing status		
Check the state of wear of the seals		
Strange noises	Stator/rotor bonding	Perform warm-up and possibly overhaul the pump
	Possible wear of the gear motor	Check the condition of the gear motor

10 END OF LIFE

End-of-life refers to all those activities that put the component out of service. End-of-life activities can be:

- **Storage**, i.e. when the component is placed inside the warehouse for an unspecified period waiting for a third party to buy the component;
- **Dismantling**, i.e. when the component has reached the end of work period, whether it is due to age, obsolescence or faults that cannot be repaired, or that it is possible to repair but it is worth buying a new component.

If installation is not planned soon, the component can remain packaged and must be stored in a sheltered and preferably closed place. The ambient temperatures to be observed are given in [chapter 2.2](#).

On the other hand, for the dismantling and consequent scraping of the component or its parts, the different nature of the various components must be considered, and a differentiated scrapping must be carried out. We recommend that you commission specialist companies for this purpose and must always observe the applicable laws on waste disposal.