

USE AND MAINTENANCE MANUAL

MANUAL DOSING VALVE DAV 100

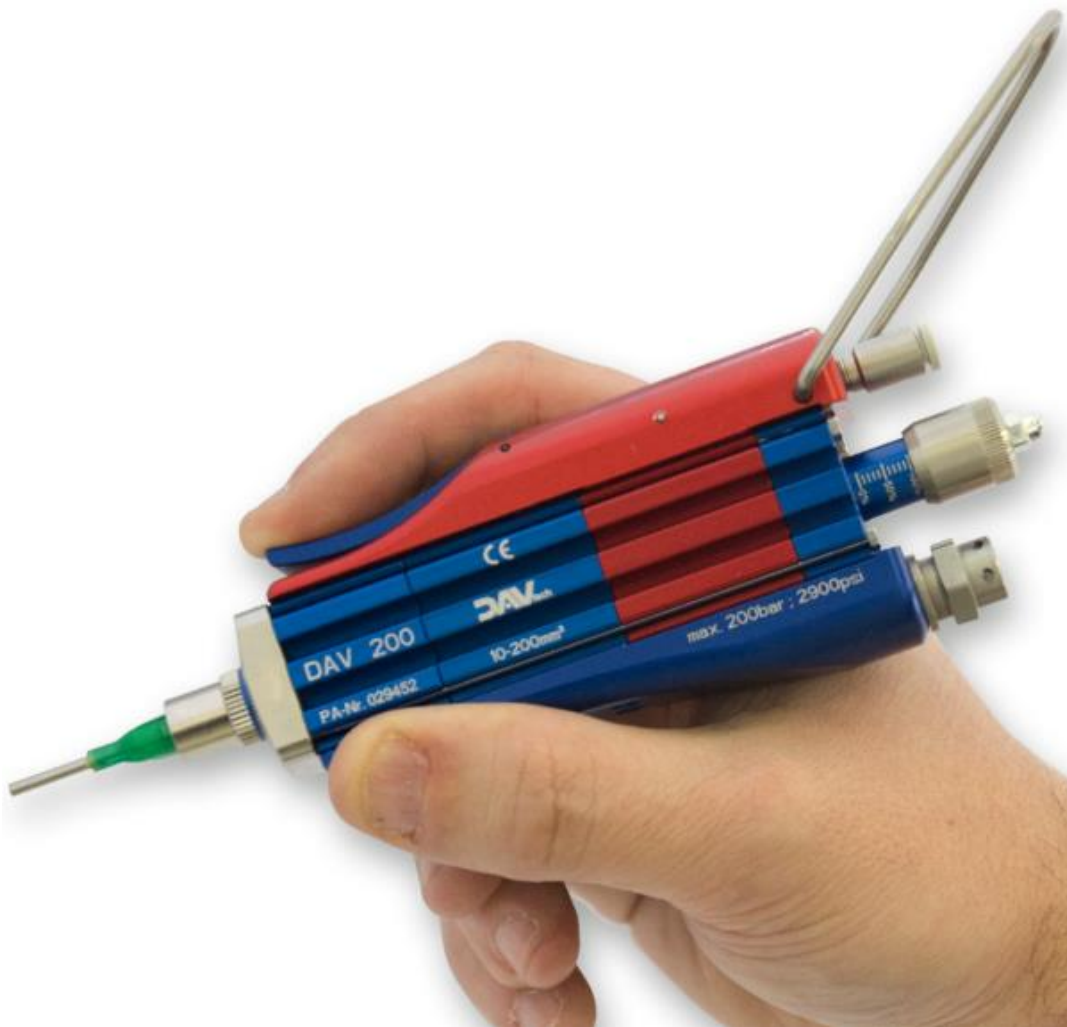

Summary

- 1 GENERAL INFORMATION..... 1**
 - 1.1 SYMBOLOGY.....2
 - 1.2 REFERENCE STANDARDS.....3
 - 1.3 DECLARATION OF INCORPORATION (ANNEX II B DIR. 2006/42/EC).....4
 - 1.4 GLOSSARY.....5
 - 1.5 SERVICE AND MANUFACTURER CONTACT DETAILS.....6
- 2 PRESENTATION AND OPERATION 7**
 - 2.1 EXPLODED.....12
 - 2.2 TECHNICAL DATA.....14
- 3 SAFETY 16**
 - 3.1 MACHINE SAFETY DEVICES.....17
 - 3.2 FREE USEFUL SPACES.....17
 - 3.3 RISK AREAS AND RESIDUAL RISK.....17
- 4 TRANSPORT AND HANDLING..... 17**
- 5 INSTALLATION 18**
 - 5.1 POSITIONING.....18
 - 5.2 CONNECTIONS.....18
 - 5.2.1 *Electric*.....19
 - 5.2.2 *Pneumatic*.....19
 - 5.3 COMMISSIONING.....20
- 6 SOFTWARE..... 20**
- 7 PROCEDURE 20**
 - 7.1 FIRST START.....21
 - 7.2 MICROMETRIC ADJUSTMENT.....21
 - 7.3 NOZZLE ADAPTER REPLACEMENT.....22
- 8 MAINTENANCE 23**
 - 8.1 DISASSEMBLY AND REASSEMBLY OF THE VALVE.....25
- 9 TROUBLESHOOTING..... 30**
- 10 END OF LIFE..... 31**

1 GENERAL INFORMATION

This manual contains information regarding the installation, use, maintenance and end of life of the component and provides indications for the most suitable behavior for correct operation. This manual has been designed to be simple and as straightforward as possible, with a subdivision into chapters and sub-chapters that allows you to find any information you need quickly. In addition, the manual begins by giving a general description of the contents, then an overview of the component, to arrive at aspects of safety, transport, installation and use and finally to the end of life. If you have any doubts about the interpretation or reading of this document, please contact the manufacturer.



DAV Tech declines any responsibility relating to improper use of the component. Observe the specifications in this manual.



Read this manual before handling the component or performing any action on it.



The manual is an essential safety requirement and must accompany the component throughout its life cycle.

It is the task of the end user to optimize the functionality of the component, always considering the purpose for which it was built.



You are asked to keep this manual, together with the attached documentation, in good condition, legible and complete. In addition, it must be stored in the vicinity of the component or, in any case, in a place accessible and known to all personnel who use the component itself or who must perform maintenance or inspection interventions. If the manual deteriorates or is no longer complete, a copy must be requested from the manufacturer, indicating the code of the manual and the revision.



The manual is intended for personnel who use the component (operators), who perform maintenance on it (maintenance technicians), and for personnel who must perform checks or inspections. The manufacturer is not liable for damage to the component caused by personnel who have not followed the instructions in the manual.

If you have any doubts about the correct interpretation of the information contained in this manual, please contact the manufacturer.

GUARANTEE

During the design phase, a careful choice of materials and components to be used in the project was made and they were subjected to regular testing before delivery. All elements have been designed and manufactured with an adequate degree of safety, such as to be able to withstand stresses greater than those of normal use.

The warranty is valid for a period of 12 months from the date of commissioning and in any case no longer than 15 months from the date of delivery. Work carried out during the warranty period does not extend the warranty period in any way.

The manufacturer is not liable for defects due to normal wear and tear of parts which, by their nature, decay.

1.1 Symbology

Below are the symbols that are used to give a greater impact to the importance of the concept you want to give.



ATTENTION!

Refers to a warning that could lead to minor damage (minor injuries, damage to the component requiring maintenance work).



DANGER!

It refers to a major event that could cause major damage (death, permanent injury, irreversible breakage of the component).



NOTE. Indicate relevant information or insight.



OBLIGATION. It indicates a task that must be performed, related to both the component and the manual.



REFERENCE. Links to an external document that is important to view

In addition, the list of symbols is integrated with that of the personnel responsible for using the component and its function, together with other symbols used within the manual.



Operator

A (qualified) person capable of operating the component, adjusting, cleaning, starting or resetting the component. The operator is not authorized to perform maintenance.



Mechanical maintenance technician

Qualified technician able to carry out mechanical, adjustment, maintenance and routine repair work described in this manual. He is not authorized to carry out interventions on electrical systems in the presence of voltage.



Electrical maintenance technician

Qualified technician able to carry out electrical, adjustment, maintenance and routine repair work described in this manual. It can work in the presence of voltage on electrical cabinets and junction boxes. He is not authorized to carry out interventions on the mechanical side.



Manufacturer's technician

Qualified technician made available by the manufacturer to carry out operations of a complex nature in particular situations, or in any case as agreed with the customer.

1.2 Reference standards

The reference standards and directives of this manual are the following:

Directives

- 2006/42/EC – Machinery Directive;
- 2014/30/EU – EMC Directive (Electromagnetic Compatibility)

1.3 Declaration of incorporation (Annex II B DIR. 2006/42/EC)

Manufacturer's name: DAV Tech Srl
Address: Via G. Ravizza, 30, .36075, Montecchio Maggiore (VI)

DECLARES THAT THE ALMOST MACHINE

Component: DAV 100 MANUAL valve
Model: Manual volumetric dosing valve
Year: 2024
Intended use: Manual volumetric dispensing of fluids with viscosity less than 1,000,000 mPas

COMPLIES WITH THE INCORPORATION PROVISIONS OF DIRECTIVE 2006/42/EC

The technical documentation has been drawn up in accordance with Annex VII B, as required by the following:

- Machinery Directive 2006/42/EC of the European Parliament and Council of 17 May 2006
- **2014/30/EU:** of the European Parliament and of the Council of 26 February 2014 on the harmonization of the laws of the Member States relating to electromagnetic compatibility (recast).

IT ALSO DECLARES THAT:

- Undertakings are undertaken to provide, in response to a properly substantiated request from the national authorities, relevant information on this partly completed machine;
- The technical file was prepared by Andrea Grazioli, via Ravizza, 30, Montecchio Maggiore (VI), IT.

This quasi-machine cannot be used until the machinery on which it will be used is declared compliant with regulation 2006/42/EC.

Montecchio Maggiore, 21 May 2024

The legal representative

Andrea Grazioli

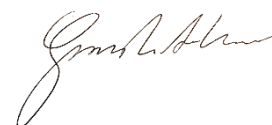

1.4 Glossary

The following are the most used terms within this manual with their meanings.

TERM	DEFINITION
Enable	Term that defines the act of preparing (enabling) an action. The action will be triggered as soon as the criteria are met, which consequently leads to the activation of the enabled action.
Active	The action that is performed instantaneously when the control is activated.
Human controls	This defines those commands that, used for manual operations, must be kept activated for the action to be performed. When the command is released, the action stops.
Two-hand controls	Human-controlled controls that require two manual controls to be operated simultaneously to perform an action.
P.P.E.	Personal protective equipment. They include all the items necessary to ensure the protection of personnel from possible accidental damage (safety shoes, gloves, helmet, and more).
Display	It is used to display information. It can be in any shape and size, even touch screen.
Manufacturer	Natural or legal person who designed and manufactured the component covered by this manual.
HP	High Pressure. An acronym that indicates high pressure.
Icon	A small image that represents a command, a function or even a document or an operating program, which appears on a computer screen. When selected by the user, it initiates the function or program it symbolizes.
Joystick	Lever manipulator used in control panels.
N.A.	Not Applicable, i.e. it indicates that it is a field that does not apply to this manual and that it cannot be integrated into the component.
Operator panel	A control station where the machine control instruments are located
P.I.	Possible Implementation, i.e. it is currently absent from the component described in this manual, but it is possible to make an addition and implement it.
Screen	Interface system between man and component. Screenshots are the images displayed on the operator panel that allow the user to receive and provide information to the management software.
Push-button panel	Composition of buttons and selectors that allow you to act directly on the behavior of the component.
Keyboard	Keyboard only (stand-alone element) or in addition to a display (keys only, no selectors or other)
Touch screen	Touch screen that allows the user to interact with a graphic interface using their fingers or objects.

1.5 Service and manufacturer contact details

For any reason relating to the use, maintenance or request of spare parts, the customer must contact the manufacturer (or the service center if present) directly, specifying the identification data of the component.

The customer can make use of the technical and commercial support of local agents or importers, who are in direct contact with the company DAV Tech Srl.

Company name	DAV Tech Srl
Postal address	Via Ravizza, 30, 37065, Montecchio Maggiore (VI) – (IT)
Telephone	+39 0444 574510
Fax	+39 0444 574324
email	davtech@davtech.it
Website	www.davtech.it

2 PRESENTATION AND OPERATION

In this manual you want to learn more about the operation of the DAV 100 valve with manual configuration. In this case, the valve does not need special solenoid valves for its operation, since the piston is controlled by the operation of the button pressed by the operator.

In other words, the function of this component is:

MANUAL VOLUMETRIC DISPENSING OF LOW, MEDIUM AND HIGH VISCOSITY FLUIDS

Intended use is the use described in the chapter below, while improper use is considered any other use that is not described in this manual, with products of different material and format from those for which it was built.

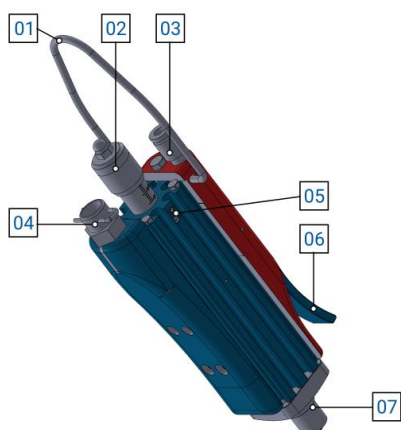

Figure 01 – DAVM 100 detail

No.	DESCRIPTION
01	Valve support
02	Micrometric adjustment
03	Pneumatic inlet
04	Fluidic inlet
05	Adjustment lock
06	Dosing button
07	Fluid output

Before using a certain type of fluid, it is necessary to check that:

- The viscosity of the fluid is compatible with the characteristics of the valve;
- The characteristics of the fluid meet the desired requirements;
- The technical data sheet of the fluid provided by the manufacturer contains all the information regarding the product such as viscosity, applications, drying times and storage;
- The fluid storage time has not been exceeded;
- The fluid packages are tightly sealed.

If it is necessary to use several fluids with the same valve, it must be cleaned thoroughly to prevent residues from the previous processing from affecting the processing to be performed.

SPECIAL VERSIONS

This valve exists in various versions:

1. Version with extension for radial or frontal spraying (100, 150, 200 or 300 mm long and, on request, also custom lengths) and allow low and medium viscosity products such as oils and greases to be dispensed inside holes and cylinders;
2. Version with sensor for objectification of valve opening;

OPERATION

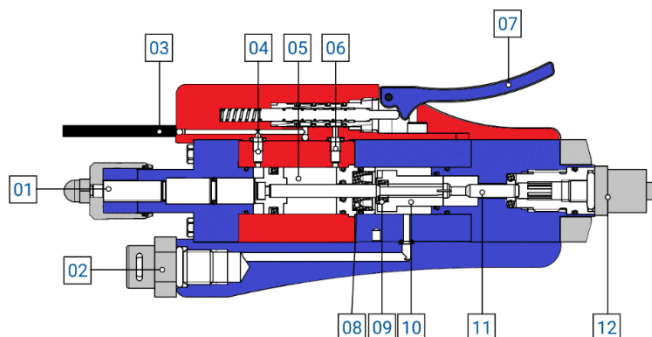

No.	DESCRIPTION
01	Micrometric adjustment
02	Fluid inlet
03	Air inlet
04	Air dosing
05	Pneumatic chamber
06	Air Charging
07	Button
08	Lip seal
09	Scraper
10	Piston
11	Pin
12	Fluid outlet nozzle

Figure 02 – DAV 100 MANUAL internal section

As you can see, the valve includes a single pneumatic inlet, which is managed by the button used by the operator; therefore, this inlet does not need automatic solenoid valves for air management.

The needle can only be adjusted by micrometric adjustment; Then, the operator turns the adjustment based on how much travel he needs to perform an optimal dosage.

For minimum working pressures, please refer to [Chapter 2.2](#).

The valves cannot operate autonomously. To ensure that it dispenses product, they must be connected to a power source, which can be a tank, a pump or other, depending on the system and the customer's needs.

ATTENTION!



It is recommended to connect the valves to the sources indicated in this manual in [chapter 2.2](#). Connecting them to other sources or products with features not listed in this manual may break them.

The valves are also equipped with an adjustment screw, which is used to determine how much product to dose. In practice, the adjustment of the pin determines the amount of product dispensed. To use the screw, you can turn clockwise to decrease the stroke of the needle and, therefore, the amount of fluid dispensed (until it is completely closed); Turning in the other direction increases the amount of fluid delivered.

Below we want to explain the operation of the DAV 100 MANUAL tubes.

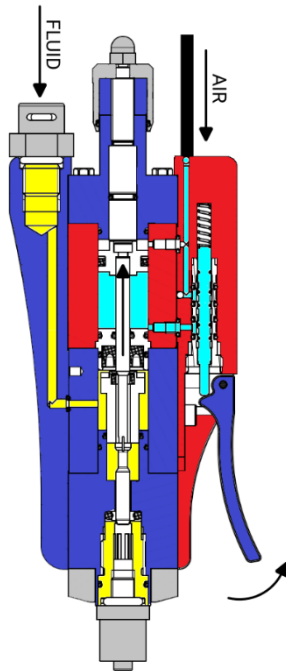

Figure 03 – Resting phase

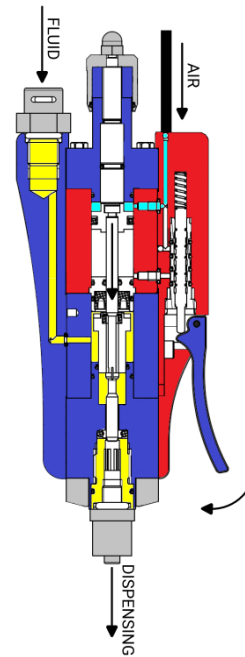

Figure 04 – Dosing phase

The fluid is constantly pushed inside the valve, keeping it under pressure and keeping the fluidic chamber always full of fluid ready to be dosed. The air coming from the line is used to keep the valve closed. As soon as the operator presses the button, the piston diverts the air flow into the other chamber, applying pressure on the piston that pushes the needle forward and performs the dosing. A peculiarity of this valve is that the dosage is not continuous; Then, once the predetermined amount of fluid has been dispensed, the operator must release the button to allow the valve to prepare for dosing again. So, in general, the toggle sequence is as follows:

- The fluid is ready to exit into its special chamber (Figure 03);
- The portion of the needle resting on the scraper does not allow the fluid to escape;
- The operator presses the button, moving the pneumatic piston that allows the air to be diverted;
- The air pushes the piston towards the outlet nozzle, thus also pushing the needle;
- The needle, due to the section with a smaller diameter, does not seal on the scraper, allowing the fluid to escape;
- At the end of the stroke, the needle stops and closes the fluidic chamber and the nozzle, preventing further fluid from escaping (Figure 04);
- When the operator releases the button, the pneumatic piston returns to its initial position;
- The air draws the piston and needle towards the micrometric adjustment;
- The fluidic chamber opens, allowing the product to be refilled, but preventing it from coming out of the valve.

USEFUL TIPS

- The smaller the amount of fluid to be dosed, the smaller the nozzle size must be;
- The distance between the nozzle and the surface is crucial, because if the nozzle is too far away, there is no proper adhesion to the surface and therefore the fluid is sucked in. Therefore, the distance between the nozzle and the surface must be adjusted according to the amount of fluid to be dosed;
- In general, it is recommended to use a conical nozzle (the overall dimensions must be considered);
- The higher the pressure of the fluid, the more the fluid adheres to the surface. If desired, by increasing the grease pressure, the valve can be moved away from the surface itself (always consult the technical office or tests on this aspect);
- The objectification sensor may not take correct readings if the valve opening is less than 20%. If you must use it in this mode, you can request a special sensor;
- A sensor can also be used to objectify the closure of the valve;
- If you must use a custom nozzle, you must pay attention to the length of the thread, which, if too long, impacts with the advance of the needle, risking ruining it and, above all, risking that the dosage does not take place, given the operation of the valve;
- It is possible to heat the fluid through special circuits in case its viscosity needs to be decreased.

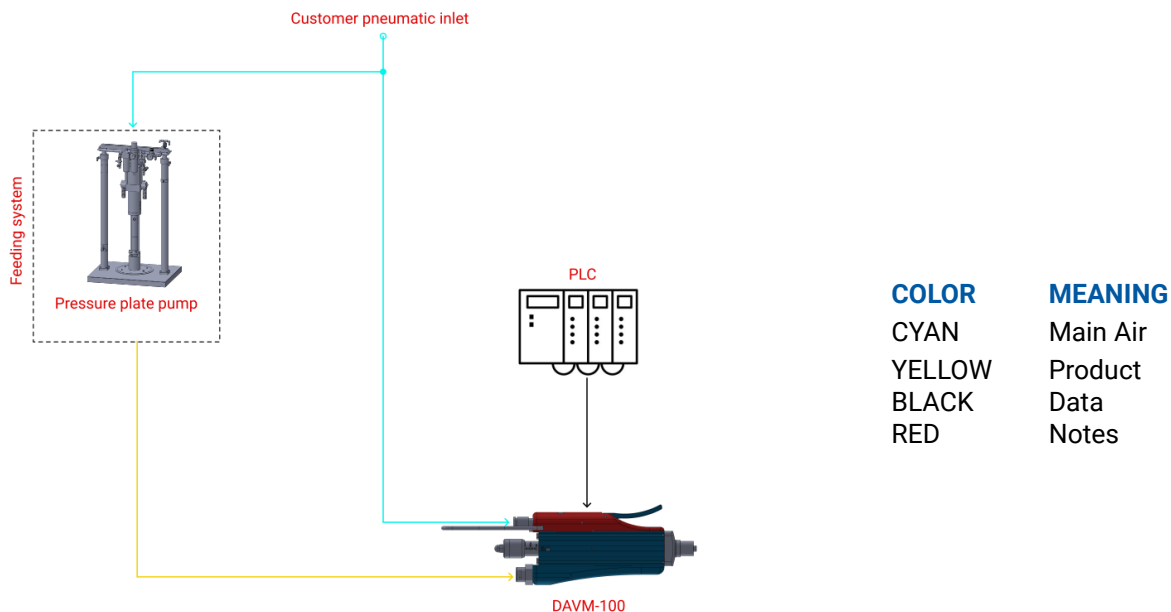

Figure 05 – Connection example



ATTENTION!

The air entering the valve must be filtered and without water (dried), otherwise it risks forming oxide inside the component and wearing it out more quickly.

2.1 Exploded

The following is a list of the main valve components with spare part numbers.

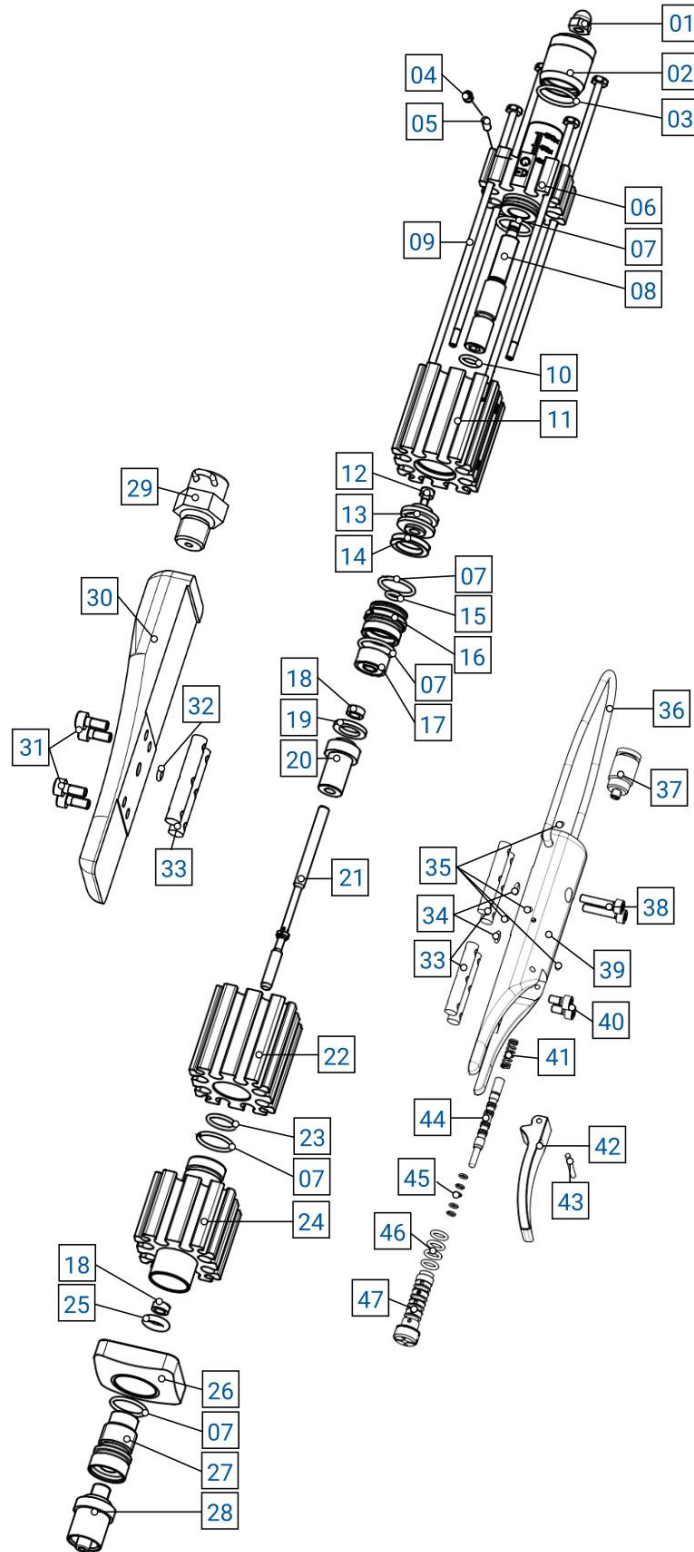

No.	Description	Var.	Code	Variant details
01	NUT	-	8411400	Draught torque = 1.2 Nm
02	MICROMETRIC ADJUSTMENT	-	0001042	-
03	O-RING	-	8225600	-
04	GRUB SCREW	-	8510101	-
05	PIN	-	0001227	-
06	BODY ADJUSTMENT	-	0004890	-
07	O-RING	-	8224301	-
08	STOPPER	-	0001045	-
09	SCREW	-	0001228	Draught torque = 0.3 Nm
10	O-RING	-	8221600	-
11	PNEUMATIC BODY	-	0004891	-
12	SCREW PIN	-	0001226	Draught torque = 0.4 Nm
13	PNEUMATIC PISTON	-	0001043	-
14	X-RING	-	0001106	-
15	O-RING	-	8220400	-
16	BUSH	-	0001041	-
17	LIP SEAL	-	8353502	-
18	SCRAPER	-	8221401	-
19	MAGNETIC RING	-	0001044	-
20	VOLUMETRIC CHAMBER	-	0001038	-
21	PIN	-	0001039	-
22	INTERMEDIATE BODY	-	0004892	-
23	O-RING	-	8227800	-
24	FRONT BODY	-	0004894	-
25	O-RING	-	8221400	-
26	FIXING PLATE	-	0004971	-
27	LUER LOCK BUSH	-	0001037	-
28	LUER LOCK ADAPTER	-	0001019	-
29	NIPPLE INLET	-	0002004	Draught torque = 12.5Nm
30	FLUIDIC GRIP BODY	-	0002088	-
31	SCREW	-	8423900	Draught torque = 0.5 Nm
32	O-RING	-	0001224	-
33	NUT	-	0002213	-
34	O-RING	-	8220100	-
35	SPHERE	-	8210700	-
36	HOOK	-	4240400	-
37	AIR CONNECTION	-	0002099	-
38	SCREW	-	8423906	Draught torque = 0.5 Nm
39	PNEUMATIC HANDLE BODY	-	0002084	-
40	SCREW	-	8423901	Draught torque = 0.5 Nm
41	COMPRESSION SPRING	-	0002102	-
42	BUTTON	-	0002122	-
43	CYLINDRICAL PIN	-	0002101	-
44	VALVE PISTON	-	0002086	-
45	O-RING	-	0001779	-
46	O-RING	-	8220900	-
47	VALVE BODY	-	0002087	-
\	COMPLETE GASKET KIT	-	GASKETKIT-DAV100200	Excluding handle seals

2.2 Technical data

All the technical characteristics concerning the component of this manual are indicated below.

SPECIFICATIONS		
Description	UdM	Values
Model	\	DAV-100 MANUAL
Activation	\	Manual
Fluid pressure range	bar	20 ÷ 200
Air pressure for the drive	bar	5 ÷ 7
Air inlet connection	\	M2.5 for Ø4mm pipes
Fluid inlet thread	\	1/8" G
Dosage rate	cm ³	0.001 – 0.02
Fluid outlet thread	\	Nozzle 1/8" G
		M5 nozzle
		Luer lock needle holder
Maximum dosing frequency	cycles/min	60
Passage adjustment	\	Micrometric
Materials used	\	Stainless steel
		Aluminum

ENVIRONMENTAL CHARACTERISTICS		
Description	UdM	Values
Working Ambient Temperature	°C	5 ÷ 45
Storage Ambient Temperature	°C	-20 ÷ 55
Permissible non-condensing humidity	%	5 ÷ 90

USABLE FLUIDS		
Grease		
Lubricants from NLGI 0 to NLGI 3 up to 10 ⁶ mPas		

DIMENSIONAL AND WEIGHT CHARACTERISTICS

Description	UdM	Value
Component length (min ÷ max)	mm	137
Component depth (min ÷ max)	mm	40.5
Component height (min ÷ max)	mm	54
Component weight	kg	0.23

Component

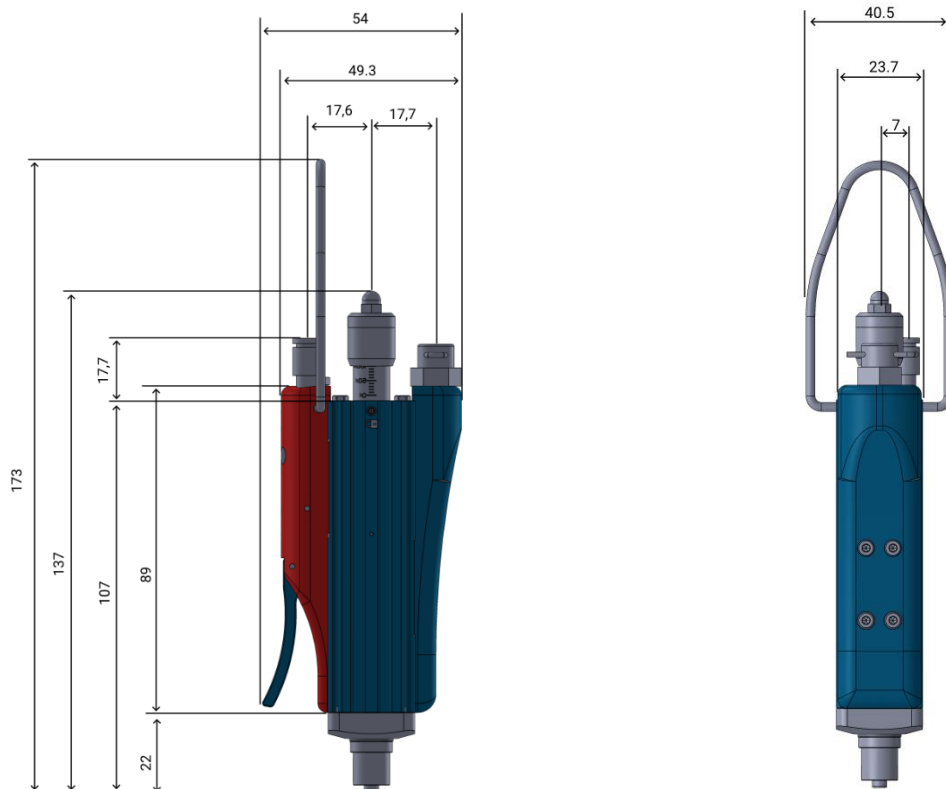

You can request the 3D of the component in the desired version from the manufacturer without any obligation.

3 SAFETY

The following is a list of warnings regarding the component covered by this manual. Please read carefully before proceeding to the next chapters.



DANGER!

Before operating the component or performing any action on it, read this manual carefully.



DANGER!

Do not use the component while under the influence of drugs or other substances that may impair attention and reaction ability.



DANGER!

Operators must only perform operations or interventions that are within the competence of the role and qualification assigned.



FIRE/EXPLOSION HAZARD!

This component is not designed to work in an ATEX environment.



DANGER!

Be very careful when servicing the component, especially when disassembling components that have pressure springs inside.



ATTENTION!

Modifications to the component must not be made to achieve performance other than that for which it was designed and built, unless authorized by the manufacturer.



ATTENTION!

Avoid introducing foreign bodies, even small ones, into the pneumatic system, which could cause the system to malfunction and compromise the safety of the machine.



The component may only be used by trained and authorized operators and for the sole purpose for which it was designed and manufactured.



The component is manufactured in compliance with the technical safety standards in force at the time of its construction.

3.1 Machine safety devices

N.A.

3.2 Free useful spaces

N.A.

3.3 Risk areas and residual risk

N.A.

4 TRANSPORT AND HANDLING

Once you have received the goods, you must check that the packaging is intact and that there is an exact correspondence with the material ordered.



ATTENTION!

The original configuration of the component must not be changed. The manufacturer is not liable for damage caused by inappropriate use of the component.



ATTENTION!

If the packaging is not intact, contact the manufacturer immediately, also sending photos of the condition of the packaging. Do not open it until you have notified the manufacturer.

5 INSTALLATION



The installation of the component is carried out by the customer. If necessary, you can contact the manufacturer to have a specialist technician help you.

The valve has been designed to be used manually, so the hook attached to the valve itself (number 01, figure 01, [chap. 2](#)) must be used to put the valve to rest.



It is recommended that you perform a component check before beginning the installation. If it is evidently damaged, please contact the manufacturer.



ATTENTION!

Please remove the packaging with the utmost care. If damage is caused to the component, the manufacturer is not liable.



Dispose of the packaging correctly, considering the different nature of the components and following the regulations in force in the country.

5.1 Positioning







N.A.

5.2 Connections

In this chapter, we want to explain the connection method that must be used for the component. The following types of connection are provided:

- Electrical connection;
- Pneumatic connection;







5.2.1 Electric

Authorized personnel		PPE to wear					
Component status	Component installed						
Power Values	See chapter 2.2						
Necessary preparations	Working electrical system						
Materials needed	\						
Equipment needed	Wrench or screwdriver						

 The electricity connection is at the expense of the customer.

For this type of valve, there is an electrical installation that concerns only the sensor side, i.e. the limit switches on the valves. In this case, to be able to read the values and to be able to make the opening and closing of the valve automatic, the sensor cables must be connected to the appropriate PLC and in the place provided by the wiring diagram.

5.2.2 Pneumatic

Authorized personnel		PPE to wear					
Component status	Component installed						
Power Values	See chapter 2.2						
Necessary preparations	Working pneumatic air system						
Materials needed	Fixing screws (for centering holes)						
Equipment needed	Wrench or screwdriver						

 The pneumatic connection is the responsibility of the customer.

For connections, it is recommended to connect the pneumatic hose first (or both in the case of double-acting work) and then proceed with the connection of the product hose (using the data given in [chapter 2.2](#)).

5.3 Commissioning

The commissioning of the component is carried out once the positioning and connection of the connections has been completed. Before commissioning the component, the following checks must be carried out:

- Check that the connections have been connected correctly;
- Check that the component is free of dirt or residues of various kinds;



ATTENTION!

If even one of the above points does not comply, commissioning must not be carried out. Commissioning should only be carried out when all points have been successfully completed.

6 SOFTWARE

N.A.

7 PROCEDURE

In this chapter we want to explain the main configurations that can be used on the component covered by this manual. In particular, we want to explain in detail:

- First start;
- Micrometric adjustment
- Nozzle adapter type replacement

It should be noted that, being a volumetric valve, the output fluid depends only on the adjustment of the needle.

7.1 First start

To perform the first start of the valve, follow these steps:

1. Fill the fluid supply hose before connecting a metering valve, to remove the air from the hose;
2. Connect the fluid supply hose to the appropriate housing and the air to the respective pneumatic connections;
3. Set the maximum dosage, i.e. loosen the locking screw and turn the micrometer knob until it stops (you should see 100%);
4. If the pressure inside the valve is high and you struggle to turn the knob, it is recommended that you take a dosage while turning the knob. By doing so, the pressure inside the chamber decreases and it is possible to perform the adjustment;
5. To prevent tampering, it is recommended to tighten the locking grub screw.



Maintain the nozzle/application point distance, to increase dosing accuracy;



The cycle time depends on the viscosity of the fluid and the pneumatic pressure of the fluid.

7.2 Micrometric adjustment

In this case, the adjustment knob must be adjusted (see [chapter 2](#), figure 01, number 01), to adjust the amount of fluid dispensed with extreme precision, namely:

- Turn counterclockwise to increase the needle stroke and therefore the amount of fluid dispensed;
- Turn clockwise to decrease the needle stroke and therefore the amount of fluid dispensed. If the valve reaches the end of its stroke, it is not completely closed but delivers the minimum value ([chapter 2.2](#)).



To facilitate the adjustment of the amount of fluid to be dispensed, it is recommended to keep the valve in dosing mode for the entire time of adjustment, so that the needle is towards the nozzle and not towards the adjustment.

7.3 Nozzle adapter replacement

This procedure is used to change the type of adapter from a LUER connection to a 1/8" GAS adapter.

DANGER!

Before performing this procedure, it is necessary to relieve the pressure (pneumatic and fluidic) of the entire circuit and disconnect the air connection.

1. Open the valve to maximum (100%) to allow the insertion of the hex key in step 3;
2. Unscrew by hand (or with the help of pliers), remove the LUER Lock adapter (No. 29 [ch. 2.1](#));
3. Remove the LUER Lock socket (No. 28 [ch. 2.1](#)) using a 3.5mm hex wrench.

ATTENTION!

The sealing unit (scraper, No. 19, and o-ring, No. 26, [ch. 2.1](#)) must not be removed;

ATTENTION!

The pin must be fully retracted. If necessary, the valve can be disassembled to reach the hexagonal surface.

ATTENTION!

Make sure that the gaskets located after the socket are correctly positioned before attaching the new adapter

4. Screw and secure the new 1/8" GAS adapter with a 13mm wrench

The procedure can also be performed in reverse, following the last to the first steps.

8 MAINTENANCE

Maintenance interventions are all those activities that must be performed on the component which, if carried out correctly, allows it to have a longer life. In general, maintenance is divided into two groups:

- **Ordinary maintenance**, which are interventions on a regular basis or that can be carried out by the customer's staff, are the most important activities as they allow the component to be kept in good working condition;

**ATTENTION!**

Ordinary maintenance must be carried out in the manner and timing indicated in the following chapters.

- **Extraordinary maintenance**, i.e. all those interventions that are not regularly carried out or that have not been planned, or interventions that cannot be carried out by the Customer. They can also arise from the lack of routine maintenance.

**ATTENTION!**



Extraordinary maintenance work must be carried out together with the manufacturer's specialized technicians.

Regarding attendance, it must be considered that:

- **When necessary**: Operation to be carried out when the need to be carried out is seen;
- **Every machine start or job end**: Indicates a daily period, in general. This can imply every 24 hours (i.e. at the beginning of the shift of every day, or the end of the shift of every day), or even more frequently, depending on the application;
- **Long pause**: Indicates a period approximately greater than an hour;
- **Each drum change**: Indicates each time the fuel system (tank, drum, cartridge or other) is changed;
- **Each mixer disassembly**: Indicates that each time the mixer is replaced, a certain operation must be performed;
- **Weekly**: Indicates a period equal to seven calendar days;
- **Monthly**: Indicates a period equal to one calendar month;
- **Semi-annual**: Indicates a period equal to six calendar months;
- **Yearly**: Indicates a period equal to one calendar year.

**ATTENTION!**

The times given below are indicative as they depend on how the component is used. Follow the variations suggested by the technicians.

Assigned	Description	Frequency	Chapter
	Perform a test function of the valve	Every machine start-up or end of work	\
	Perform a surface cleaning of the valve	Every machine start-up or end of work	\
	Put a bit of grease on the outlet nozzle	Every end of work	\
	Cleaning and/or replacing the nozzle	Semiannual	\
	Disassembly and reassembly of the valve	Annual	8.1



ATTENTION!

Apply the grease tip at the end of the work and at every prolonged pause in the system, to preserve the fluid inside the system and the functionality of the valve itself



ATTENTION!

Only use soft brushes or cotton cloths to clean the valve.

8.1 Disassembly and reassembly of the valve

Assigned	Periodicity	Materials and equipment
	Annual	<ul style="list-style-type: none"> • Dynamometric key 0.2 bis 1.2Nm and 1 bis 6 Nm; • 1.5mm, 2mm and 2.5mm hex wrench; • Allen key kit from 1.5 to 10mm; • Special Allen key SW 3.5mm; • Hook kit (for removing gaskets); • Vise with aluminum/plastic jaws

PPE to wear



DANGER!

Before performing this procedure, you must relieve the pressure from the system and disconnect the air connection.

To carry out the disassembly and consequent reassembly of the valve, please refer to the link below as it is a procedure that involves many steps. It is therefore recommended to watch the video:



ATTENTION!

The video talks about the disassembly and reassembly of the DAV 100, which the body has the same disassembly and reassembly, changing only for the fluidic and pneumatic part.

[Link to video](#)

Here's also how to do with the photos, in case you can't open the video online:



ATTENTION!

When installing the micrometer regulator or clamping screw, pay particular attention that the thread is inserted correctly, i.e. perpendicular to the body, and not that it is inclined.



ATTENTION!

Before screwing the nozzle into place, check that the adjusting screw, or knob, is completely loose to avoid damaging the nozzle and needle. To loosen them, turn counterclockwise until they no longer resist.



ATTENTION!

The passages that are present here are the same as those of the normal DAV 100. The concept is the same, except that in the DAV 100 there is a different fluid block, and the pneumatic block is different. To disassemble the two different blocks, follow the steps here and skip the steps that refer to the fluidic block shown in the images.

- Using a special screwdriver, remove screws 31, 38 and 40 shown in [chapter 2.1](#) and check the condition of the gaskets.
- To carry out maintenance inside the pneumatic body, unscrew component 47 shown in [chapter 2.1](#) and check the state of wear of the seals inside it.

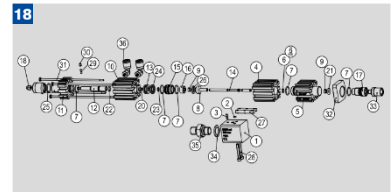
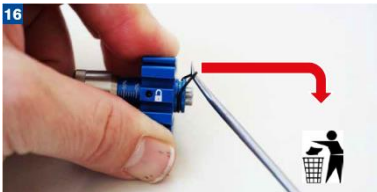
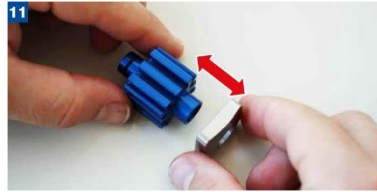
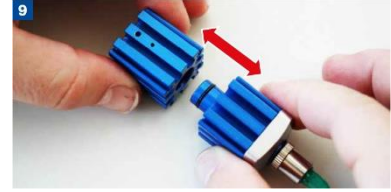
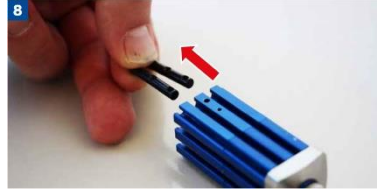
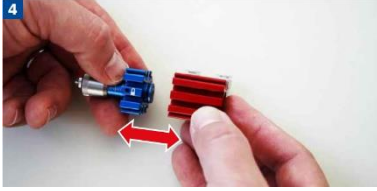
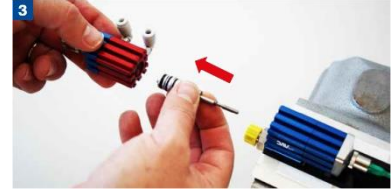
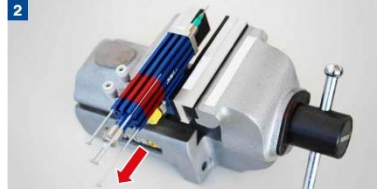

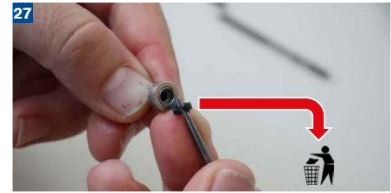
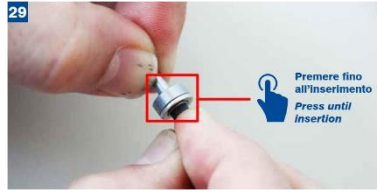

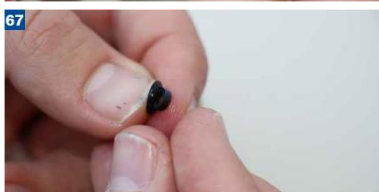
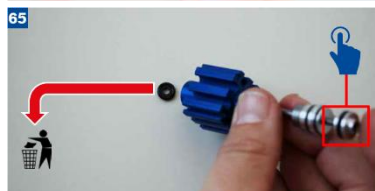
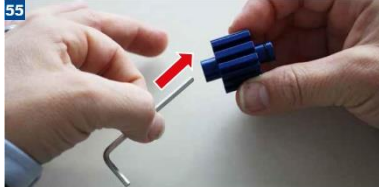

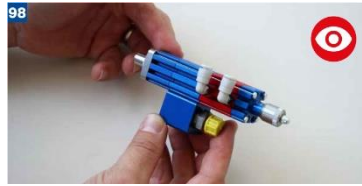
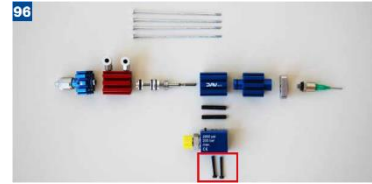
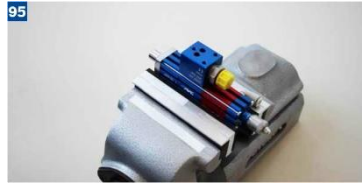
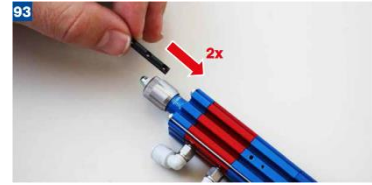
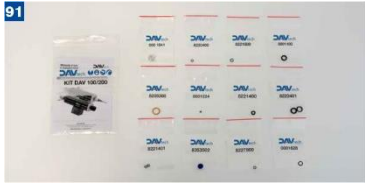
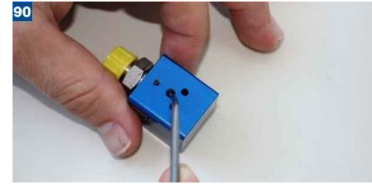
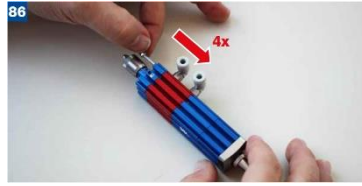
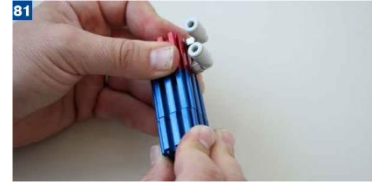
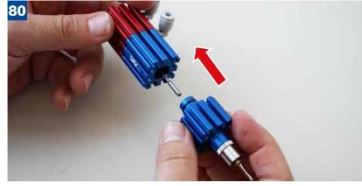
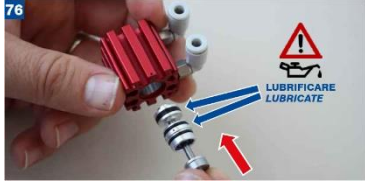
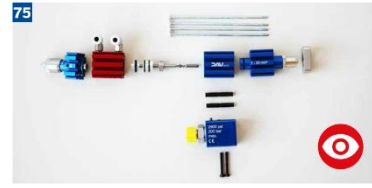
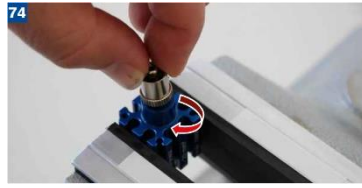

9 TROUBLESHOOTING

This chapter deals with the most common problems that may arise when using the component of this manual.

ATTENTION!

Once the operator has found a problem or assumes that there is a problem, they must call the technician in charge of maintenance. Maintenance should always be performed by a specialized and qualified technician.

DEFECT	CAUSE	SOLUTION
Not very fluent or not very fluid	Clogged valve	Remove obstructions
	The valve does not receive the command	Check the valve control (solenoid valve). Perform a manual test
	Fluid pressure is too low or no	Check the pressure of the fluid supply unit and increase it if necessary
	The nozzle is clogged	Unscrew and clean the nozzle
	The filter is dirty (if any)	Wash or replace the filter
	A tube is kinked	Check the condition of the fluid supply hoses
	Insufficient operating pressure	Check the actuation pressure (chap. 2.2)
	Fluid residues present in the system	Disassemble and clean any solid particles
	Lubricant with too high viscosity	See chapter 2.2 and fluid data sheet
Nozzle drips even if valve is not piloted	Dirt in the nozzle	Clean or replace the nozzle
	Damaged scraper	Replace scraper
	Damaged pin	Replace pin
Valve opens late	Insufficient operating pressure	Check the actuation pressure (chap. 2.2)
	O-Ring on Damaged Air Piston	Replace O-Ring on Pneumatic Piston
The valve activates, but the fluid is not expelled	The feed pump does not lubricate pump	Observe the operating instructions for the feed pump
Continuous signal from the sensor	Faulty sensor	Replace sensor
	Too little dosing volume	Check the dosage volume adjustment and increase it if necessary Check the sensor position
	Inlet pressure too high	Reduce the pressure to the maximum permissible pressure (chap. 2.2)
No signal from the sensor	Broken cable	Replace the cable
	Faulty sensor	Replace the sensor
	Inlet pressure too low	Increase the pressure to the minimum permissible pressure (chap. 2.2)
Air in the system	Air bubbles in the lubricant container	Loosen the inlet hose. Vent the system.
	Air bubbles in the pipes	Reassemble the inlet hose.
Non-hermetic valve	Defective or damaged seal	Replace the gasket
Irregular dosage	Control air applied too early	Switching can only take place if no more material is ejected

10 END OF LIFE

End-of-life refers to all those activities that put the component out of service. End-of-life activities can be:

- **Storage**, i.e. when the component is placed inside the warehouse for an unspecified period waiting for a third party to buy the component;
- **Dismantling**, i.e. when the component has reached the end of work period, whether it is due to age, obsolescence or faults that cannot be repaired, or that it is possible to repair but it is worth buying a new component.

If installation is not planned soon, the component can remain packaged and must be stored in a sheltered and preferably closed place. The ambient temperatures to be observed are given in [chapter 2.2](#).

On the other hand, for the dismantling and consequent scrapping of the component or its parts, the different nature of the various components must be considered, and a differentiated scrapping must be carried out. We recommend that you commission specialist companies for this purpose and must always observe the applicable laws on waste disposal.