

USE AND MAINTENANCE MANUAL

VOLUMETRIC DOSING VALVE DAV 100



Summary

1	GENERAL INFORMATION	1
1.1	SYMBOLY	2
1.2	REFERENCE STANDARDS	3
1.3	DECLARATION OF INCORPORATION (ANNEX II B DIR. 2006/42/EC)	4
1.4	GLOSSARY	5
1.5	SERVICE AND MANUFACTURER CONTACT DETAILS	6
2	PRESENTATION AND OPERATION	7
2.1	EXPLODED	12
2.2	TECHNICAL DATA	14
3	SAFETY	16
3.1	MACHINE SAFETY DEVICES	17
3.2	FREE USEFUL SPACES	17
3.3	RISK AREAS AND RESIDUAL RISK	17
4	TRANSPORT AND HANDLING	17
5	INSTALLATION	18
5.1	POSITIONING	18
5.2	CONNECTIONS	18
5.2.1	<i>Electric</i>	19
5.2.2	<i>Pneumatic</i>	19
5.3	COMMISSIONING	20
6	SOFTWARE	20
7	PROCEDURE	21
7.1	FIRST START	21
7.2	MICROMETRIC ADJUSTMENT	21
7.3	NOZZLE ADAPTER REPLACEMENT	22
8	MAINTENANCE	23
8.1	DISASSEMBLY AND REASSEMBLY OF THE VALVE	25
9	TROUBLESHOOTING	30
10	END OF LIFE	31

1 GENERAL INFORMATION

This manual contains information regarding the installation, use, maintenance and end of life of the component and provides indications for the most suitable behavior for correct operation. This manual has been designed to be simple and as straightforward as possible, with a subdivision into chapters and sub-chapters that allows you to find any information you need quickly. In addition, the manual begins by giving a general description of the contents, then an overview of the component, to arrive at aspects of safety, transport, installation and use and finally to the end of life. If you have any doubts about the interpretation or reading of this document, please contact the manufacturer.



DAV Tech declines any responsibility relating to improper use of the component. Observe the specifications in this manual.



Read this manual before handling the component or performing any action on it.



The manual is an essential safety requirement and must accompany the component throughout its life cycle.

It is the task of the end user to optimize the functionality of the component, always considering the purpose for which it was built.



You are asked to keep this manual, together with the attached documentation, in good condition, legible and complete. In addition, it must be stored in the vicinity of the component or, in any case, in a place accessible and known to all personnel who use the component itself or who must perform maintenance or inspection interventions. If the manual deteriorates or is no longer complete, a copy must be requested from the manufacturer, indicating the code of the manual and the revision.



The manual is intended for personnel who use the component (operators), who perform maintenance on it (maintenance technicians), and for personnel who must perform checks or inspections. The manufacturer is not liable for damage to the component caused by personnel who have not followed the instructions in the manual.

If you have any doubts about the correct interpretation of the information contained in this manual, please contact the manufacturer.

GUARANTEE

During the design phase, a careful choice of materials and components to be used in the project was made and they were subjected to regular testing before delivery. All elements have been designed and manufactured with an adequate degree of safety, such as to be able to withstand stresses greater than those of normal use.

The warranty is valid for a period of 12 months from the date of commissioning and in any case no longer than 15 months from the date of delivery. Work carried out during the warranty period does not extend the warranty period in any way.

The manufacturer is not liable for defects due to normal wear and tear of parts which, by their nature, decay.

1.1 Symbology

Below are the symbols that are used to give a greater impact to the importance of the concept you want to give.



ATTENTION!

Refers to a warning that could lead to minor damage (minor injuries, damage to the component requiring maintenance work).



DANGER!

It refers to a major event that could cause major damage (death, permanent injury, irreversible breakage of the component).



NOTE. Indicate relevant information or insight.



OBLIGATION. It indicates a task that must be performed, related to both the component and the manual.



REFERENCE. Links to an external document that is important to view

In addition, the list of symbols is integrated with that of the personnel responsible for using the component and its function, together with other symbols used within the manual.



Operator

A (qualified) person capable of operating the component, adjusting, cleaning, starting or resetting the component. The operator is not authorized to perform maintenance.



Mechanical maintenance technician

Qualified technician able to carry out mechanical, adjustment, maintenance and routine repair work described in this manual. He is not authorized to carry out interventions on electrical systems in the presence of voltage.



Electrical maintenance technician

Qualified technician able to carry out electrical, adjustment, maintenance and routine repair work described in this manual. It can work in the presence of voltage on electrical cabinets and junction boxes. He is not authorized to carry out interventions on the mechanical side.



Manufacturer's technician

Qualified technician made available by the manufacturer to carry out operations of a complex nature in particular situations, or in any case as agreed with the customer.

1.2 Reference standards

The reference standards and directives of this manual are the following:

Directives

- 2006/42/EC – Machinery Directive;

1.3 Declaration of incorporation (Annex II B DIR. 2006/42/EC)

Manufacturer's name: DAV Tech Srl
Address: Via G. Ravizza, 30, .36075, Montecchio Maggiore (VI)

DECLARES THAT THE ALMOST MACHINE

Component: The Book of Dav 100
Model: Volumetric dosing valve
Year: 2024
Intended use: Volumetric dispensing of fluid with viscosity between NLGI0 and NLGI 3

COMPLIES WITH THE INCORPORATION PROVISIONS OF DIRECTIVE 2006/42/EC

The technical documentation has been drawn up in accordance with Annex VII B, as required by the following:

- Machinery Directive 2006/42/EC of the European Parliament and Council of 17 May 2006

IT ALSO DECLARES THAT:

- Undertakings are undertaken to provide, in response to a properly substantiated request from the national authorities, relevant information on this partly completed machine;
- The technical file was prepared by Andrea Grazioli, via Ravizza, 30, Montecchio Maggiore (VI), IT.

This quasi-machine cannot be used until the machinery on which it will be used is declared compliant with regulation 2006/42/EC.

Montecchio Maggiore, 19 January 2024

The legal representative

Andrea Grazioli

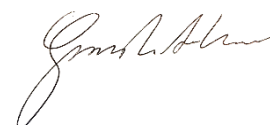

1.4 Glossary

The following are the most used terms within this manual with their meanings.

TERM	DEFINITION
Enable	Term that defines the act of preparing (enabling) an action. The action will be triggered as soon as the criteria are met, which consequently leads to the activation of the enabled action.
Active	The action that is performed instantaneously when the control is activated.
Human controls	This defines those commands that, used for manual operations, must be kept activated for the action to be performed. When the command is released, the action stops.
Two-hand controls	Human-controlled controls that require two manual controls to be operated simultaneously to perform an action.
D.P.I.	Personal protective equipment. They include all the items necessary to ensure the protection of personnel from possible accidental damage (safety shoes, gloves, helmet, and more).
Display	It is used to display information. It can be in any shape and size, even touch screen.
Manufacturer	Natural or legal person who designed and manufactured the component covered by this manual.
Icon	A small image that represents a command, a function or even a document or an operating program, which appears on a computer screen. When selected by the user, it initiates the function or program it symbolizes.
Joystick	Lever manipulator used in control panels.
N.A.	Not Applicable, i.e. it indicates that it is a field that does not apply to this manual and that it cannot be integrated into the component.
Operator panel	A control station where the machine control instruments are located
P.I.	Possible Implementation, i.e. it is currently absent from the component described in this manual, but it is possible to make an addition and implement it.
Screen	Interface system between man and component. Screenshots are the images displayed on the operator panel that allow the user to receive and provide information to the management software.
Push-button panel	Composition of buttons and selectors that allow you to act directly on the behavior of the component.
Keyboard	Keyboard only (stand-alone element) or in addition to a display (keys only, no selectors or other)
Touch screen	Touch screen that allows the user to interact with a graphic interface using their fingers or objects.

1.5 Service and manufacturer contact details

For any reason relating to the use, maintenance or request of spare parts, the customer must contact the manufacturer (or the service center if present) directly, specifying the identification data of the component.

The customer can make use of the technical and commercial support of local agents or importers, who are in direct contact with the company DAV Tech Srl.

Company name	DAV Tech Srl
Postal address	Via Ravizza, 30, 37065, Montecchio Maggiore (VI) – (IT)
Telephone	+39 0444 574510
Fax	+39 0444 574324
email	davtech@davtech.it
Website	www.davtech.it

2 PRESENTATION AND OPERATION

In this manual we want to expose the DAV 100, a volumetric dosing valve that is pneumatically controlled and is well suited for dispensing low, medium or high viscosity fluids that are not abrasive. The pneumatic part of the valve is controlled by 5/2 solenoid valve; Therefore, dosing starts from the hydraulic part of the system and depends on the set pressure of the fluid.

In other words, the function of this component is:

VOLUMETRIC DISPENSING OF FLUID WITH VISCOSITY BETWEEN NLGI 0 AND NLGI 3

Intended use is the use described in the chapter below, while improper use is considered any other use that is not described in this manual, with products of different material and format from those for which it was built.

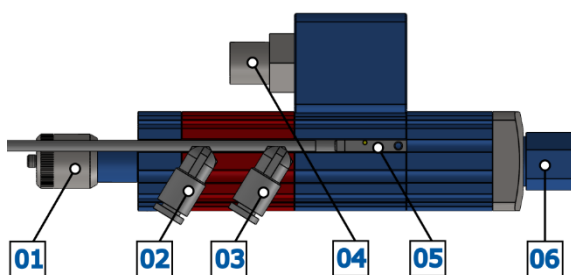

No.	DESCRIPTION
01	Adjustment knob
02	Dosing air inlet
03	Air inlet loading
04	Product Input
05	Objectification sensor
06	Product Output

Figure 01 – Detail DAV 100 – DAV 200

Before using a certain type of fluid, it is necessary to check that:

- The viscosity of the fluid is compatible with the characteristics of the valve;
- The characteristics of the fluid meet the desired requirements;
- The technical data sheet of the fluid provided by the manufacturer contains all the information regarding the product such as viscosity, applications, drying times and storage;
- The fluid storage time has not been exceeded;
- The fluid packages are tightly sealed.

If it is necessary to use several fluids with the same valve, it must be cleaned thoroughly to prevent residues from the previous processing from affecting the processing to be performed.

OPERATION

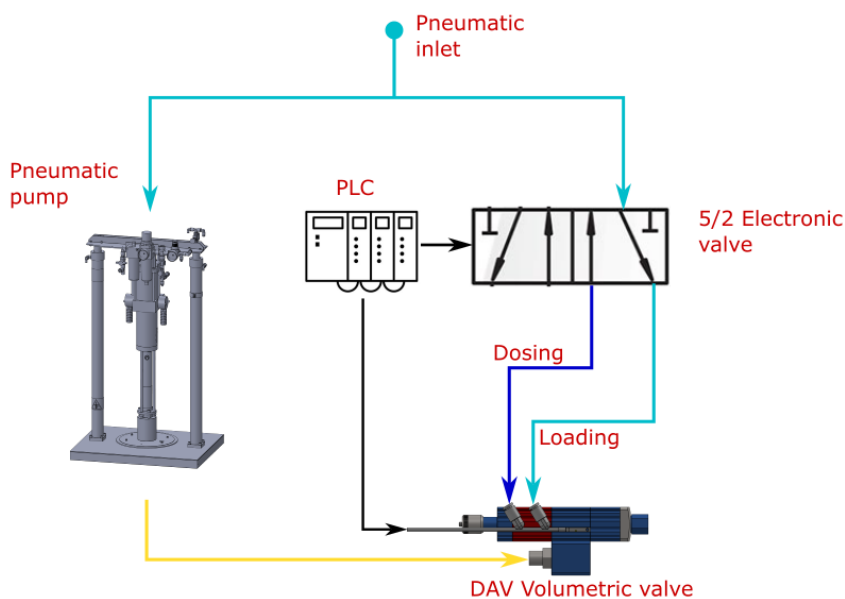

COLOR	MEANING
BLUE	Air dispensing
CYAN	Air Loading
YELLOW	Product
BLACK	Data
RED	Notes

Figure 02 – Connection Example



ATTENTION!

The air entering the valve must be filtered and without water (dried), otherwise it risks forming oxide inside the component and wearing it out more quickly.

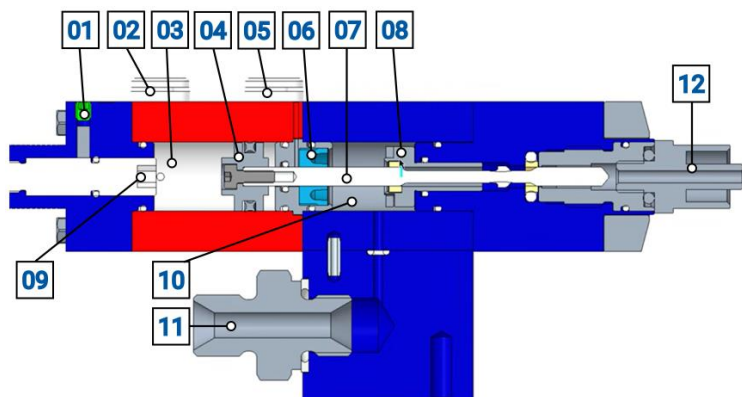

No.	DESCRIPTION
01	Regulator lock
02	Dosing air inlet
03	Pneumatic chamber
04	Air piston
05	Air inlet loading
06	Compass
07	Pin
08	Flowing Pistone
09	Regulator shaft
10	Fluidic chamber
11	Fluidic inlet
12	Fluid output

Figure 03 – DAV 100 internal section

This valve has a single working mode, i.e. by means of a 5/2 valve it performs a volumetric punctual dosing; Through micrometric adjustment, it is possible to calibrate the amount of fluid to be dosed, while through the pressure of the fluid, the flow of fluid passing through the outlet nozzle is calibrated.

For minimum working pressures, please refer to [Chapter 2.2](#).

The valve cannot operate autonomously. To ensure that it dispenses product, it must be connected to a power source, which can be a pump or other, depending on the system and the customer's needs.

**ATTENTION!**

It is recommended that the valve be connected to the sources indicated in this manual in [chapter 2.2](#). Connecting it to other sources or products with features not listed in this manual may break them.

The following is intended to explain the operation of the DAV 100 valve via section.

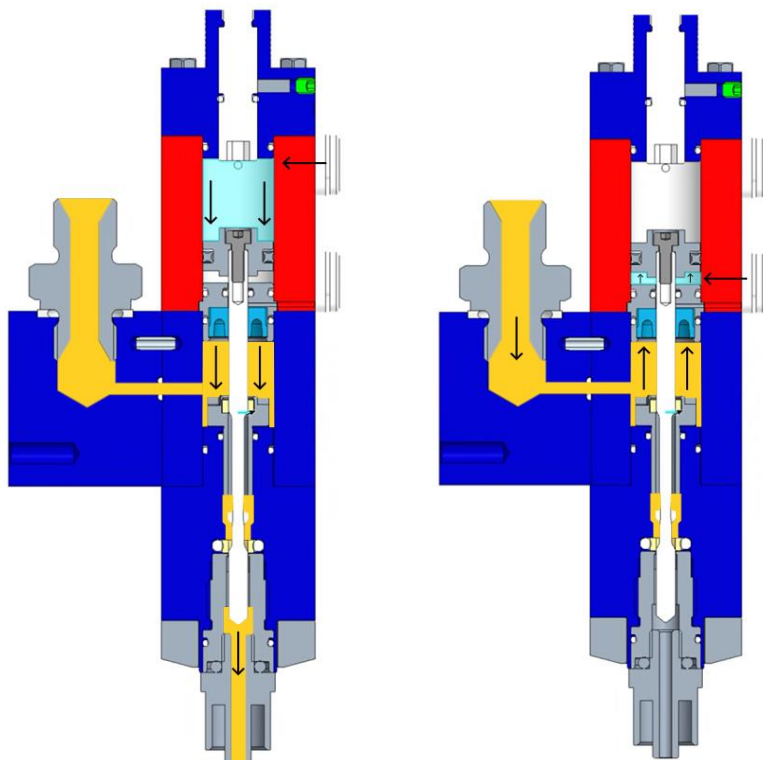

During the dosing phase, the needle starts at the height set by the regulator. From there, as soon as there is sufficient pressure (it must exceed the minimum working pressure) in the dosing chamber, the piston pushes down the entire mechanism, including the needle, which pushes a certain amount of fluid outwards. When it reaches the end of its stroke, if connected, the relative sensor signals the dosage. Once the needle reaches the end of its stroke, the dispensing stops.

Instead, when air is given into the loading chamber, the fluid piston moves upwards, resting on the needle which moves the system upwards and allows the appropriate chamber to be loaded with fluid, in preparation for a new dosage. The pneumatic piston moves up to the height adjusted with the adjusting shaft.

ATTENTION!



It is advisable to pay particular attention to the dosing nozzle, i.e. nozzle diameters and lengths must be used according to the amount of volume dispensed and the type of fluid. If you are unsure, contact the manufacturer.

ATTENTION!



If a micrometric adjustment is to be made, the position of the sensor that detects the start of the piston stroke inside the fluid chamber must be corrected

USEFUL TIPS

- The smaller the amount of fluid to be dosed, the smaller the nozzle size must be;
- The distance between the nozzle and the surface is crucial, because if the nozzle is too far away, there is no proper adhesion to the surface and therefore the fluid is sucked in. Therefore, the distance between the nozzle and the surface must be adjusted according to the amount of fluid to be dosed;
- In general, it is recommended to use a conical nozzle (the overall dimensions must be considered);
- The higher the pressure of the fluid, the more the fluid adheres to the surface. If desired, by increasing the grease pressure, the valve can be moved away from the surface itself (always consult the technical office or tests on this aspect);
- The objectification sensor may not take correct readings if the valve opening is less than 20%. If you must use it in this mode, you can request a special sensor;
- A sensor can also be used to objectify the closure of the valve;
- If you must use a custom nozzle, you must pay attention to the length of the thread, which, if too long, impacts with the advance of the needle, risking ruining it and, above all, risking that the dosage does not take place, given the operation of the valve;
- It is possible to heat the fluid through special circuits in case its viscosity needs to be decreased.

2.1 Exploded

The following is a list of the main valve components with spare part numbers.

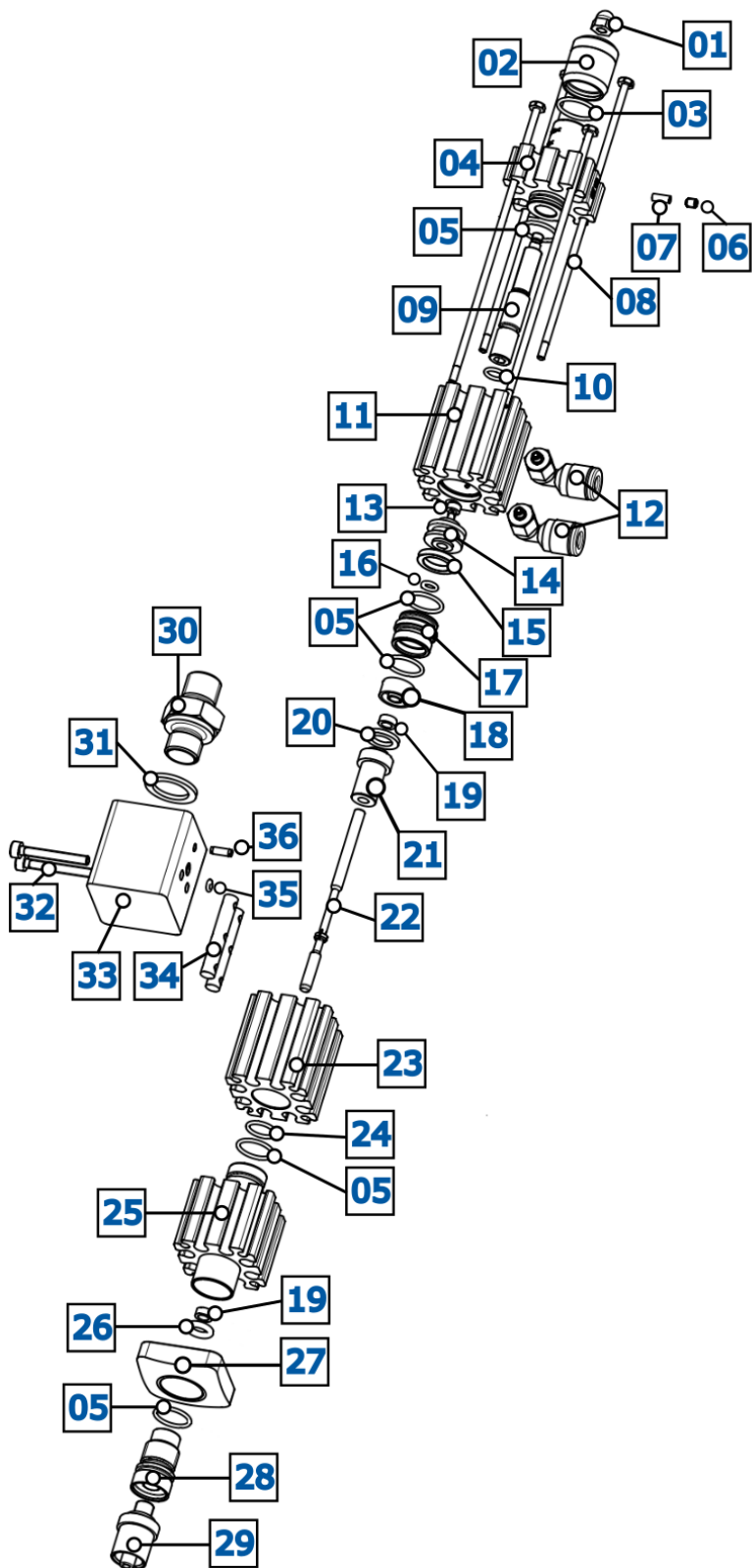

No.	Description	Var.	Code	Variant details
01	CAP NUT	-	8411400	-
02	MICROMETRIC ADJUSTMENT	-	0001042	-
03	O-RING	-	8225600	-
04	BODY ADJUSTMENT	-	0004890	-
05	O-RING		8223401	
06	SCREW		8510101	
07	CYLINDRICAL PIN		0001227	
08	SCREW		0001228	
09	STOPPER		0001045	
10	O-RING		8221600	
11	PNEUMATIC BODY		0004891	
12	AIR CONNECTION		0002633	
13	SCREW PIN		0001226	
14	PNEUMATIC PISTON		0001043	
15	X-RING		0001106	
16	O-RING		8220400	
17	SLEEVE		0001041	
18	LIP SEAL		8353502	
19	ROD SEAL		8221401	
20	MAGNETIC RING		0001044	
21	VOLUMETRIC CHAMBER	-	0001038	
22	PIN		0001039	
23	INTERMEDIATE BODY		0004892	
24	O-RING		8227800	
25	FRONT BODY		0004894	
26	O-RING		8221400	
27	FACEPLATE		0004971	
28	ADAPTER		0001037	
29	NEEDLE ADAPTER		0001019	
30	NIPPLO INLET		8573307	
31	GASKET RING		8259300	
32	SOCKET HEAD SCREW		8423904	
33	CONNECTION BODY		0004895	
34	FIXING NUTS		0002213	
35	O-RING		0001224	
36	SPRING PIN		8460002	
\	COMPLETE GASKET KIT		GASKETKIT-DAV100200	

2.2 Technical data

All the technical characteristics concerning the component of this manual are indicated below.

SPECIFICATIONS		
Description	UdM	Values
Model	\	DAV 100
Activation	\	Double Effect
Maximum fluid pressure	bar	20 ÷ 200
Air pressure for the drive	bar	5 ÷ 8
Dosage rate	cm ³	0.001 – 0.02
Air inlet thread	\	M2.5 (Ø4mm pipe fittings)
Fluid inlet thread	\	1/8 GAS
Optimal working distance to the surface	mm	N.A.
Optimal working angle with respect to perpendicular to the work surface	°	N.A.
Fluid outlet thread	\	M5 with luer lock needle holder
		1/8 GAS female fitting
Maximum control frequency	cycles/min	60
Quantity Adjustment Method	\	Micrometric with tamper-proof grain
Materials used	\	Stainless steel
		aluminum

ENVIRONMENTAL CHARACTERISTICS		
Description	UdM	Values
Working Ambient Temperature	°C	5 ÷ 45
Storage Ambient Temperature	°C	-20 ÷ 40
Permissible non-condensing humidity	%	5 ÷ 90

USABLE FLUIDS		
Grease		
Lubricants from NLGI 0 to NLGI 3 and at 106 mPa x s		

DIMENSIONAL AND WEIGHT CHARACTERISTICS

Description	UdM	Value
Component length (min ÷ max)	mm	137
Component depth (min ÷ max)	mm	23,7
Component height (min ÷ max)	mm	47,2
Component weight	kg	0.17

Component

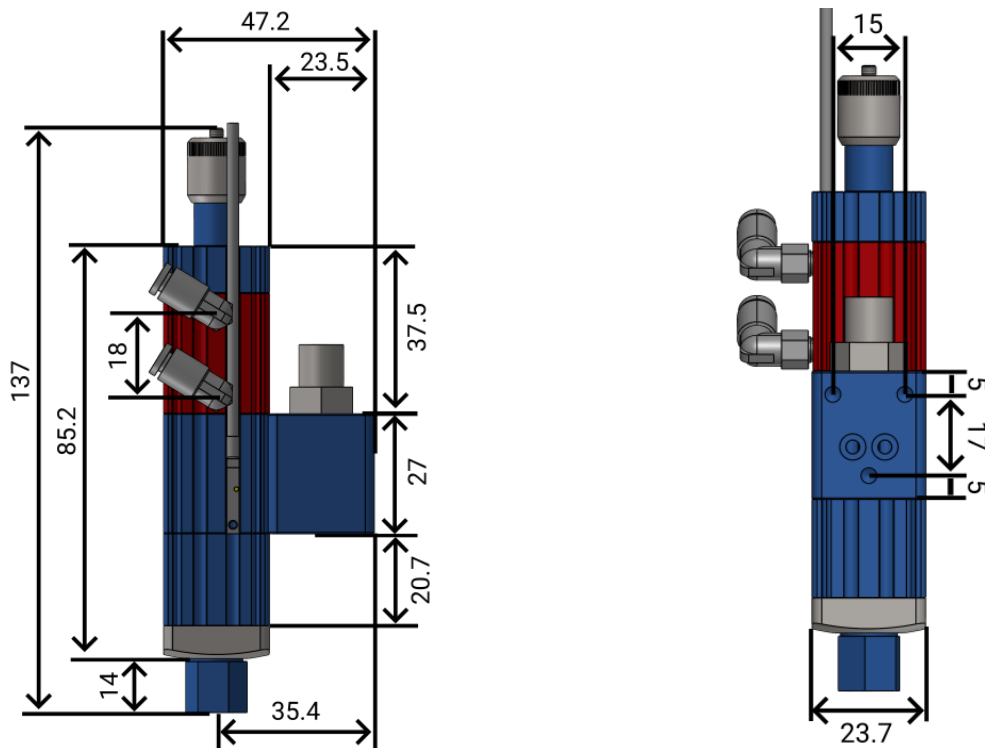

You can request the 3D of the component in the desired version from the manufacturer without any obligation.

3 SAFETY

The following is a list of warnings regarding the component covered by this manual. Please read carefully before proceeding to the next chapters.



DANGER!

Before operating the component or performing any action on it, read this manual carefully.



DANGER!

Do not use the component while under the influence of drugs or other substances that may impair attention and reaction ability.



DANGER!

Operators must only perform operations or interventions that are within the competence of the role and qualification assigned.



FIRE/EXPLOSION HAZARD!

This component is not designed to work in an ATEX environment.



DANGER!

Be very careful when servicing the component, especially when disassembling components that have pressure springs inside.



ATTENTION!

Modifications to the component must not be made to achieve performance other than that for which it was designed and built, unless authorized by the manufacturer.



ATTENTION!

Avoid introducing foreign bodies, even small ones, into the pneumatic system, which could cause the system to malfunction and compromise the safety of the machine.



The component may only be used by trained and authorized operators and for the sole purpose for which it was designed and manufactured.



The component is manufactured in compliance with the technical safety standards in force at the time of its construction.

3.1 Machine safety devices

N.A.

3.2 Free useful spaces

N.A.

3.3 Risk areas and residual risk

There are the following residual risks on the component:

- **Dangers due to electricity:** the passage of pressurized fluid generates static electricity which, if touched by personnel who are not properly isolated, can be dangerous;
- **Hazards due to inhalation of hazardous vapors:** The component is not designed to have insulation from any toxic and/or hazardous vapors; personnel working with this device should be aware of this during its use;
- **Fire hazard due to vapors:** Personnel working near this component must not have any heat sources that could start a fire;
- **Risk due to fluid projection under pressure:** Due to incorrect maintenance of the component, it can lead to the expulsion of some parts of the component and consequent expulsion of fluid.

4 TRANSPORT AND HANDLING

Once you have received the goods, you must check that the packaging is intact and that there is an exact correspondence with the material ordered.



ATTENTION!

The original configuration of the component must not be changed. The manufacturer is not liable for damage caused by inappropriate use of the component.



ATTENTION!

If the packaging is not intact, contact the manufacturer immediately, also sending photos of the condition of the packaging. Do not open it until you have notified the manufacturer.

5 INSTALLATION



The installation of the component is carried out by the customer. If necessary, you can contact the manufacturer to have a specialist technician help you.

The valves covered by this manual have threaded holes near the lubricant inlet fitting. Through these holes, it is possible to fix the valve on any surface designed to house it (for the spacing of the holes, see [chapter 2.2](#)). It is recommended to make a good fixing of the valve itself, as vibrations could take it off-axis and give suboptimal dosing results.



It is recommended that you perform a component check before beginning the installation. If it is evidently damaged, please contact the manufacturer.



ATTENTION!

Please remove the packaging with the utmost care. If damage is caused to the component, the manufacturer is not liable.



Dispose of the packaging correctly, considering the different nature of the components and following the regulations in force in the country.

5.1 Positioning







N.A.

5.2 Connections

In this chapter, we want to explain the connection method that must be used for the component. The following types of connection are provided:

- Electrical connection;
- Pneumatic connection;

5.2.1 Electric







Authorized personnel	 PPE to wear					
Component status	Component installed and turned off					
Power Values	See chapter 2.2					
Necessary preparations	Working electrical system					
Materials needed	\					
Equipment needed	Wrench or screwdriver					



The electricity connection is at the expense of the customer.

For this type of valve, there is an electrical installation that concerns only the sensor side, i.e. the limit switches on the valves. In this case, to be able to read the values and to be able to make the opening and closing of the valve automatic, the sensor cables must be connected to the appropriate PLC and in the place provided by the wiring diagram.

5.2.2 Pneumatic

Authorized personnel	 PPE to wear					
Component status	Component installed and turned off					
Power Values	See chapter 2.2					
Necessary preparations	Working pneumatic air system					
Materials needed	Fixing screws (for centering holes)					
Equipment needed	Wrench or screwdriver					



The pneumatic connection is the responsibility of the customer.

Before assembling the valve, it is recommended to calibrate the valve, so as to carry it out precisely and once carried out, you can proceed with the assembly and possible fixing by screws on the appropriate seats. For connections, it is recommended to connect the pneumatic hoses first and then proceed with the connection of the product hose (using the data given in [chapter 2.2](#)).

5.3 Commissioning

The commissioning of the component is carried out once the positioning and connection of the connections has been completed. Before commissioning the component, the following checks must be carried out:

- Check that the connections have been connected correctly;
- Check that the component is free of dirt or residues of various kinds;



ATTENTION!

If even one of the above points does not comply, commissioning must not be carried out. Commissioning should only be carried out when all points have been successfully completed.

6 SOFTWARE

N.A.

7 PROCEDURE

In this chapter we want to explain the main configurations that can be used on the component covered by this manual. We want to explain in detail:

- How to perform the first start of the component;
- How to perform needle adjustment via micrometric configuration;
- How to change nozzle adapter.

It should be noted that the output fluid does not depend only on the needle adjustment, but also on other factors, namely:

- **Nozzle diameter:** the larger the nozzle diameter, the lower the output speed;
- **Fluid pressure:** the higher the fluid pressure, the higher the flow and output speed;
- **Adjusting the pin stroke:** The larger the pin stroke, the higher the output quantity.

7.1 First start

To perform the first start of the valve, follow these steps:

1. Fill the lubricant supply hose before connecting a metering valve, to remove the air from the hose;
2. Connect the fluid supply hose to the appropriate housing and the air to the respective pneumatic connections;
3. Set the maximum dosage, i.e. loosen the locking screw and turn the micrometer knob until it stops (you should see 100%);
4. If the pressure inside the valve is high and you have difficulty turning the knob, it is recommended that you perform a dosage while turning the knob. By doing so, the pressure inside the chamber decreases and it is possible to perform the adjustment;
5. To prevent tampering, it is recommended to tighten the locking grub screw.



Maintain the nozzle/application point distance, to increase dosing accuracy;



The cycle time depends on the viscosity of the fluid and the pneumatic pressure of the fluid.

7.2 Micrometric adjustment

In this case, the adjustment knob must be adjusted (see [chapter 2](#), figure 01, number 01), to adjust the amount of fluid dispensed with extreme precision, namely:

- Turn counterclockwise to increase the needle stroke and therefore the amount of fluid dispensed;
- Turn clockwise to decrease the needle stroke and therefore the amount of fluid dispensed. If the valve reaches the end of its stroke, it is not completely closed but delivers the minimum value ([chapter 2.2](#)).



To facilitate the adjustment of the amount of fluid to be dispensed, it is recommended to keep the valve in dosing mode for the entire time of adjustment, so that the needle is towards the nozzle and not towards the adjustment.

7.3 Nozzle adapter replacement

This procedure is used to change the type of adapter from a LUER connection to a 1/8" GAS adapter.

**DANGER!**

Before performing this procedure, it is necessary to relieve the pressure (pneumatic and fluidic) of the entire circuit and disconnect the air connection.

1. Open the valve to maximum (100%) to allow the insertion of the hex key in step 3;
2. Unscrew by hand (or with the help of pliers), remove the LUER Lock adapter (No. 29 [chapter 2.1](#));
3. Remove the LUER Lock socket (No. 28 [chapter 2.1](#)) using a 3.5mm hex wrench.

**ATTENTION!**

The sealing unit (scraper, No. 19, and o-rings, No. 26, [chapter 2.1](#)) must not be removed;

**ATTENTION!**

The dispensing needle should be fully retracted. If necessary, the valve can be disassembled to reach the hexagonal surface.

**ATTENTION!**

Make sure that the gaskets located after the socket are correctly positioned before attaching the new adapter

4. Screw and secure the new 1/8" GAS adapter with a 13mm wrench

The procedure can also be performed in reverse, following the last to the first steps.

8 MAINTENANCE

Maintenance interventions are all those activities that must be performed on the component which, if carried out correctly, allows it to have a longer life. In general, maintenance is divided into two groups:

- **Ordinary maintenance**, which are interventions on a regular basis or that can be carried out by the customer's staff, are the most important activities as they allow the component to be kept in good working condition;



ATTENTION!

Ordinary maintenance must be carried out in the manner and timing indicated in the following chapters.

- **Extraordinary maintenance**, i.e. all those interventions that are not regularly carried out or that have not been planned, or interventions that cannot be carried out by the Customer. They can also arise from the lack of routine maintenance.



ATTENTION!

Extraordinary maintenance work must be carried out together with the manufacturer's specialized technicians.

Regarding attendance, it must be considered that:

- **When necessary**: Operation to be carried out when the need to be carried out is seen;
- **Every component start or job end**: Indicates a daily time, in general. This can imply every 24 hours (i.e. at the beginning of the shift of every day, or the end of the shift of every day), or even more frequently, depending on the application;
- **Long pause**: Indicates a period approximately greater than an hour;
- **Each drum change**: Indicates each time the fuel system (tank, drum, cartridge or other) is changed;
- **Each mixer disassembly**: Indicates that each time the mixer is replaced, a certain operation must be performed;
- **Weekly**: Indicates a period equal to seven calendar days;
- **Monthly**: Indicates a period equal to one calendar month;
- **Semi-annual**: Indicates a period equal to six calendar months;
- **Yearly**: Indicates a period equal to one calendar year.



ATTENTION!

The times given below are indicative as they depend on how the component is used. Follow the variations suggested by the technicians.

Assigned	Description	Frequency	Chapter
	Check the leak of the dosing valve	Every component start-up or end of work	\
	Check all screw fittings and valves for leaks	Every component start-up or end of work	\
	Check the seals for damage or wear	Monthly	
	Disassembly and reassembly of the valve	Yearly ⁽¹⁾	8.1

(1) This figure may vary depending on the type of fluid used and the cycle of use of the valve itself.



ATTENTION!

Use the necessary precautions if you use products that in contact with the air cross-link



ATTENTION!

Only use soft brushes or cotton cloths to clean the valve.



DANGER!

Remove all pressure from the valve before proceeding with disassembly. Some components are at high pressures, and you risk very serious injuries

8.1 Disassembly and reassembly of the valve

Assigned	Periodicity	Materials and equipment
	Annual	<ul style="list-style-type: none"> • Torque wrench 0.2 bis 1.2Nm and 1 bis 6 Nm; • 1.5mm, 2mm and 2.5mm hex wrench; • Allen key kit from 1.5 to 10mm; • Special Allen key SW 3.5mm; • Hook kit (for removing gaskets); • Vise with coated magnetic hooks

PPE to wear



DANGER!

Before performing this procedure, you must relieve the pressure from the system and disconnect the air connection.

To carry out the disassembly and consequent reassembly of the valve, please refer to the link below as it is a procedure that involves many steps. It is therefore recommended to watch the video:

[Link to video](#)

Here's also how to do with the photos, in case you can't open the video online:



ATTENTION!

When installing the micrometer regulator or clamping screw, pay particular attention that the thread is inserted correctly, i.e. perpendicular to the body, and not that it is inclined.



ATTENTION!

Before screwing the nozzle into place, check that the adjusting screw, or knob, is completely loose to avoid damaging the nozzle and needle. To loosen them, turn counterclockwise until they no longer resist.

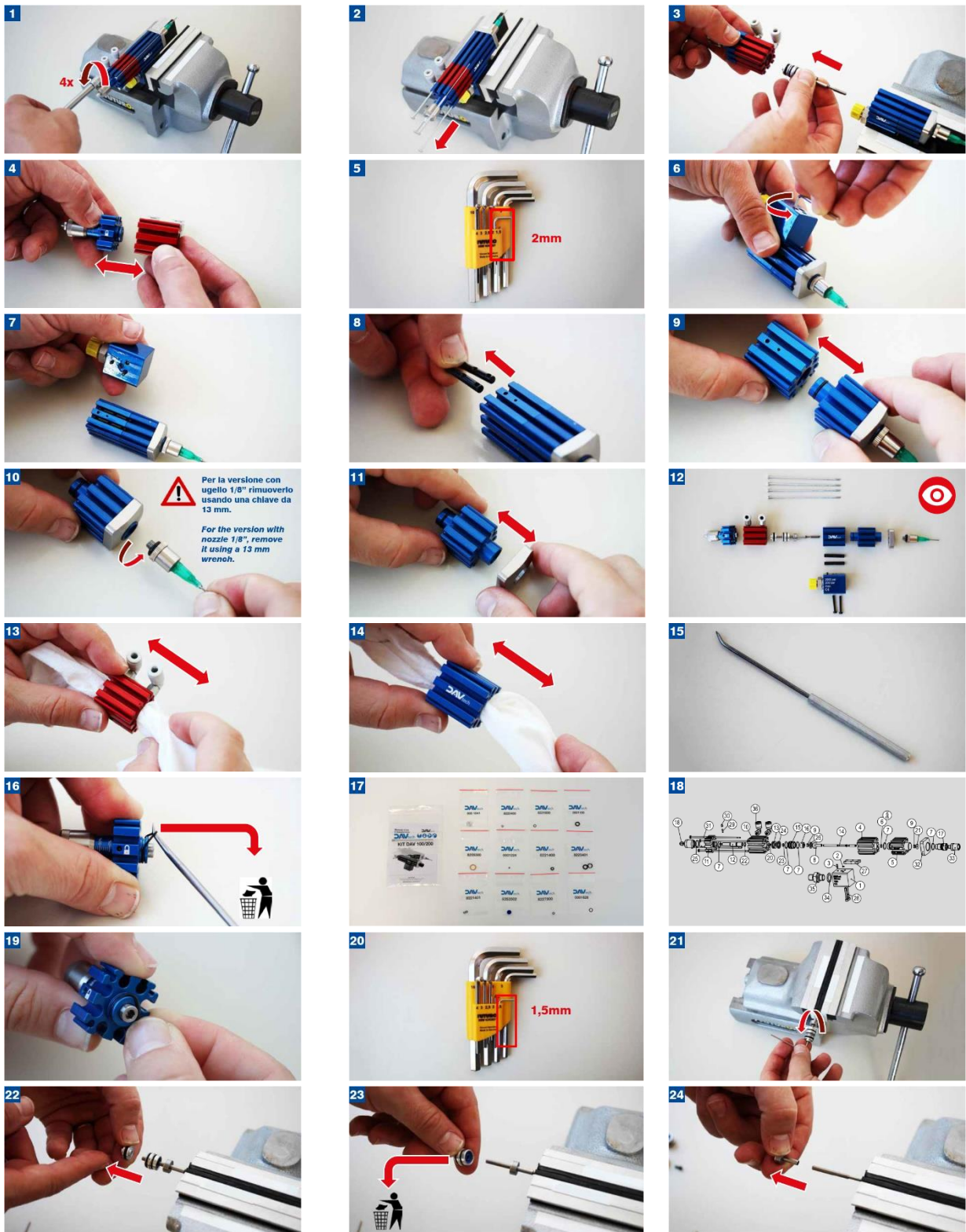

⚠ Per la versione con ugello 1/8" rimuoverlo usando una chiave da 13 mm.
For the version with nozzle 1/8", remove it using a 13 mm wrench.

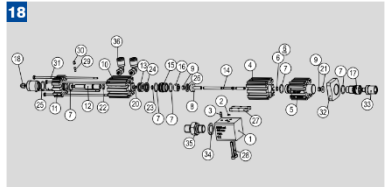
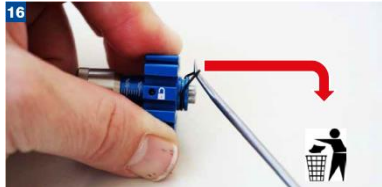

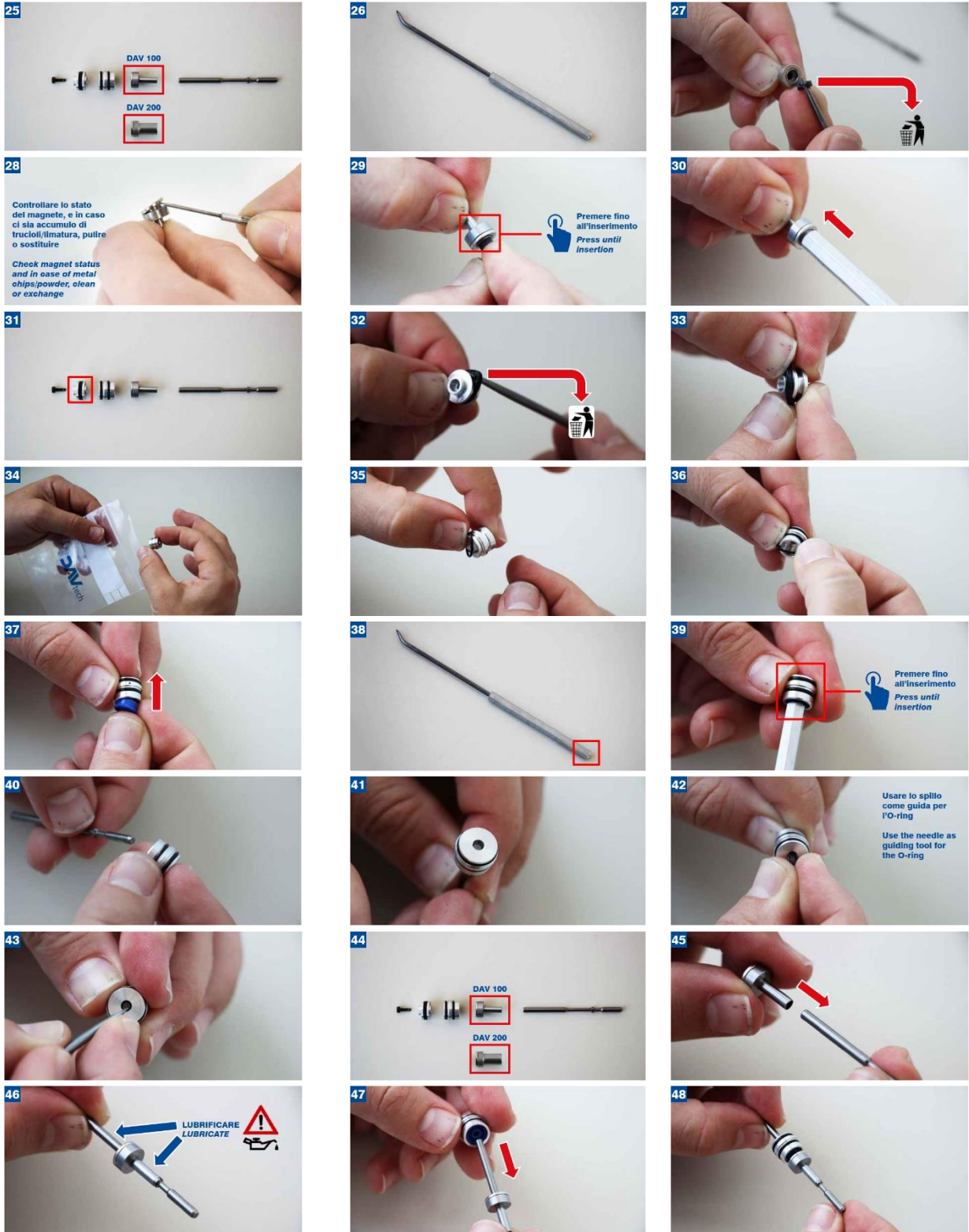

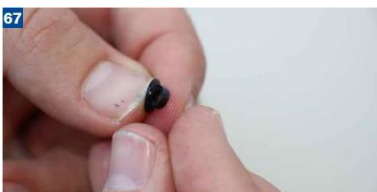
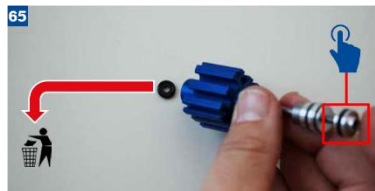
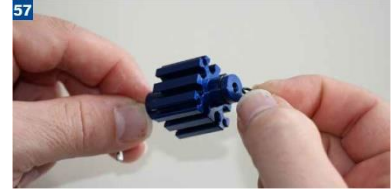
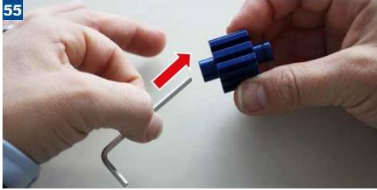

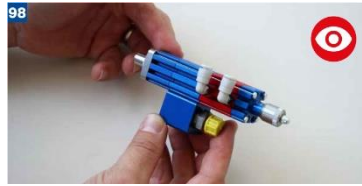
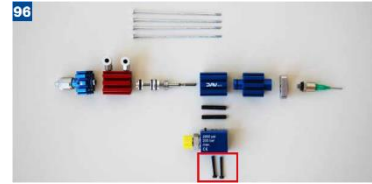
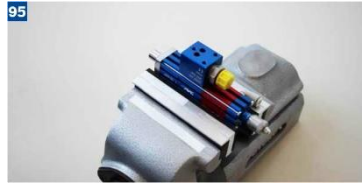
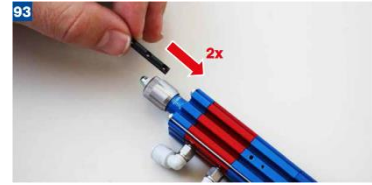
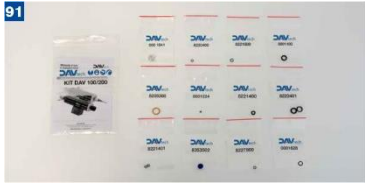
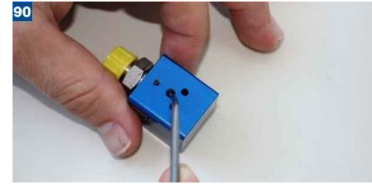
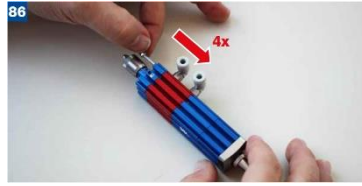
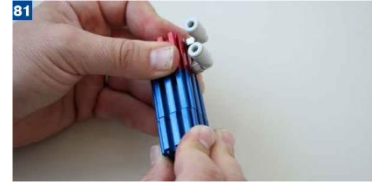
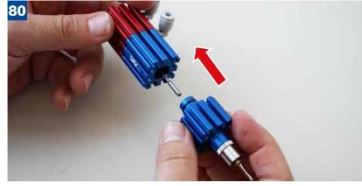
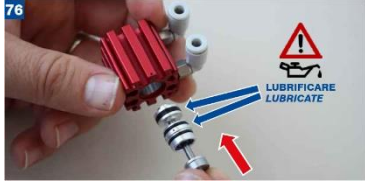
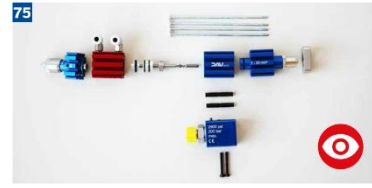
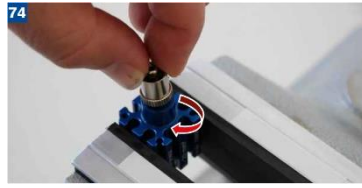

9 TROUBLESHOOTING

This chapter deals with the most common problems that may arise when using the component of this manual.

ATTENTION!

Once the operator has found a problem or assumes that there is a problem, they must call the technician in charge of maintenance. Maintenance should always be performed by a specialized and qualified technician.

DEFECT	CAUSE	SOLUTION
No fluid or little fluid exits	Clogged valve	Remove obstructions
	The valve does not receive the command	Check the valve control (solenoid valve). Perform a manual test
	Fluid pressure is too low or no pressure	Check the pressure of the fluid supply unit and increase it if necessary
	The nozzle is clogged	Unscrew and clean the nozzle
	The filter is dirty (if any)	Wash or replace the filter
	A tube is kinked	Check the condition of the fluid supply hoses
	Insufficient operating pressure	Check the actuation pressure (chap. 2.2)
	Fluid residues present in the system	Disassemble and clean any solid particles
Nozzle drips even if valve is not piloted	Lubricant with too high viscosity	See chapter 2.2 and fluid data sheet
	Dirt in the nozzle	Clean or replace the nozzle
	Damaged scraper	Replace scraper
Valve opens late	Damaged pin	Replace pin
	Insufficient operating pressure	Check the actuation pressure (chap. 2.2)
The valve activates, but the fluid is not expelled	O-Ring on Damaged Air Piston	Replace O-Ring on Pneumatic Piston
	The feed pump does not lubricate pump	Observe the operating instructions for the feed pump
Continuous signal from the sensor	Faulty sensor	Replace sensor
	Too little dosing volume	Check the dosage volume adjustment and increase it if necessary Check the sensor position
	Inlet pressure too high	Reduce the pressure to the maximum permissible pressure (chap. 2.2)
No signal from the sensor	Broken cable	Replace the cable
	Faulty sensor	Replace the sensor
	Inlet pressure too low	Increase the pressure to the minimum permissible pressure (chap. 2.2)
Air in the system	Air bubbles in the lubricant container	Loosen the inlet hose. Vent the system.
	Air bubbles in the pipes	Reassemble the inlet hose.
Non-hermetic valve	Defective or damaged seal	Replace the gasket
Irregular dosage	Control air applied too early	Switching can only take place if no more material is ejected

10 END OF LIFE

End-of-life refers to all those activities that put the component out of service. End-of-life activities can be:

- **Storage**, i.e. when the component is placed inside the warehouse for an unspecified period waiting for a third party to buy the component;
- **Dismantling**, i.e. when the component has reached the end of work period, whether it is due to age, obsolescence or faults that cannot be repaired, or that it is possible to repair but it is worth buying a new component.

If installation is not planned soon, the component can remain packaged and must be stored in a sheltered and preferably closed place. The ambient temperatures to be observed are given in [chapter 2.2](#).

On the other hand, for the dismantling and consequent scrapping of the component or its parts, the different nature of the various components must be considered and a differentiated scrapping must be carried out. We recommend that you commission specialist companies for this purpose and must always observe the applicable laws on waste disposal.