

USE AND MAINTENANCE MANUAL

DA-400 EVO NEEDLE DOSING VALVE



Summary

- 1 GENERAL INFORMATION..... 1**
 - 1.1 SYMBOLOGY.....2
 - 1.2 REFERENCE STANDARDS3
 - 1.3 DECLARATION OF INCORPORATION (ANNEX II B DIR. 2006/42/EC)4
 - 1.4 GLOSSARY.....5
 - 1.5 SERVICE AND MANUFACTURER CONTACT DETAILS6
- 2 PRESENTATION AND OPERATION 7**
 - 2.1 EXPLODED.....11
 - 2.2 TECHNICAL DATA13
- 3 SAFETY 15**
 - 3.1 COMPONENT SAFETY DEVICES.....16
 - 3.2 FREE USEFUL SPACES16
 - 3.3 RISK AREAS AND RESIDUAL RISK16
- 4 TRANSPORT AND HANDLING..... 16**
- 5 INSTALLATION 17**
 - 5.1 POSITIONING.....17
 - 5.2 CONNECTIONS.....17
 - 5.2.1 *Electric*.....18
 - 5.2.2 *Pneumatic*.....18
 - 5.3 COMMISSIONING.....19
- 6 SOFTWARE..... 19**
- 7 PROCEDURE 20**
 - 7.1 MICROMETRIC ADJUSTMENT.....20
 - 7.2 RASTER PIN BLOCK INSTALLATION21
- 8 MAINTENANCE 22**
 - 8.1 DISASSEMBLY AND REASSEMBLY OF THE VALVE24
- 9 TROUBLESHOOTING..... 26**
- 10 END OF LIFE..... 26**

1 GENERAL INFORMATION

This manual contains information regarding the installation, use, maintenance and end of life of the component and provides indications for the most suitable behavior for correct operation. This manual has been designed to be simple and as straightforward as possible, with a subdivision into chapters and sub-chapters that allows you to find any information you need quickly. In addition, the manual begins by giving a general description of the contents, then an overview of the component, to arrive at aspects of safety, transport, installation and use and finally to the end of life. If you have any doubts about the interpretation or reading of this document, please contact the manufacturer.



DAV Tech declines any responsibility relating to improper use of the component. Observe the specifications in this manual.



Read this manual before handling the component or performing any action on it.



The manual is an essential safety requirement and must accompany the component throughout its life cycle.

It is the task of the end user to optimize the functionality of the component, always considering the purpose for which it was built.



You are asked to keep this manual, together with the attached documentation, in good condition, legible and complete. In addition, it must be stored in the vicinity of the component or, in any case, in a place accessible and known to all personnel who use the component itself or who must perform maintenance or inspection interventions. If the manual deteriorates or is no longer complete, a copy must be requested from the manufacturer, indicating the code of the manual and the revision.



The manual is intended for personnel who use the component (operators), who perform maintenance on it (maintenance technicians), and for personnel who must perform checks or inspections. The manufacturer is not liable for damage to the component caused by personnel who have not followed the instructions in the manual.

If you have any doubts about the correct interpretation of the information contained in this manual, please contact the manufacturer.

GUARANTEE

During the design phase, a careful choice of materials and components to be used in the project was made and they were subjected to regular testing before delivery. All elements have been designed and manufactured with an adequate degree of safety, such as to be able to withstand stresses greater than those of normal use.

The warranty is valid for a period of 12 months from the date of commissioning and in any case no longer than 15 months from the date of delivery. Work carried out during the warranty period does not extend the warranty period in any way.

The manufacturer is not liable for defects due to normal wear and tear of parts which, by their nature, decay.

1.1 Symbology

Below are the symbols that are used to give a greater impact to the importance of the concept you want to give.



ATTENTION!

Refers to a warning that could lead to minor damage (minor injuries, damage to the component requiring maintenance work).



DANGER!

It refers to a major event that could cause major damage (death, permanent injury, irreversible breakage of the component).



NOTE. Indicate relevant information or insight.



OBLIGATION. It indicates a task that must be performed, related to both the component and the manual.



REFERENCE. Links to an external document that is important to view

In addition, the list of symbols is integrated with that of the personnel responsible for using the component and its function, together with other symbols used within the manual.



Operator

A (qualified) person capable of operating the component, adjusting, cleaning, starting or resetting the component. The operator is not authorized to perform maintenance.



Mechanical maintenance technician

Qualified technician able to carry out mechanical, adjustment, maintenance and routine repair work described in this manual. He is not authorized to carry out interventions on electrical systems in the presence of voltage.



Electrical maintenance technician

Qualified technician able to carry out electrical, adjustment, maintenance and routine repair work described in this manual. It can work in the presence of voltage on electrical cabinets and junction boxes. He is not authorized to carry out interventions on the mechanical side.



Manufacturer's technician

Qualified technician made available by the manufacturer to carry out operations of a complex nature in particular situations, or in any case as agreed with the customer.

1.2 Reference standards

The reference standards and directives of this manual are the following:

Directives

- 2006/42/EC – Machinery Directive;

1.3 Declaration of incorporation (Annex II B DIR. 2006/42/EC)

Manufacturer's name: DAV Tech Srl
Address: Via G. Ravizza, 30, .36075, Montecchio Maggiore (VI)

DECLARES THAT THE ALMOST MACHINE

Component: DA 400 EVO valve
Model: Pressure-time dosing valve with solenoid valve
Year: 2024
Intended use: Volumetric dispensing of low and medium viscosity fluid at very high frequencies

COMPLIES WITH THE INCORPORATION PROVISIONS OF DIRECTIVE 2006/42/EC

The technical documentation has been drawn up in accordance with Annex VII B, as required by the following:

- Machinery Directive 2006/42/EC of the European Parliament and Council of 17 May 2006

IT ALSO DECLARES THAT:

- Undertakings are undertaken to provide, in response to a properly substantiated request from the national authorities, relevant information on this partly completed machine;
- The technical file was prepared by Andrea Grazioli, via Ravizza, 30, Montecchio Maggiore (VI), IT.

This quasi-machine cannot be used until the machinery on which it will be used is declared compliant with regulation 2006/42/EC.

Montecchio Maggiore, 19 January 2024

The legal representative

Andrea Grazioli

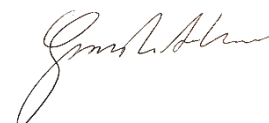

1.4 Glossary

The following are the most used terms within this manual with their meanings.

TERM	DEFINITION
Enable	Term that defines the act of preparing (enabling) an action. The action will be triggered as soon as the criteria are met, which consequently leads to the activation of the enabled action.
Active	The action that is performed instantaneously when the control is activated.
Human controls	This defines those commands that, used for manual operations, must be kept activated for the action to be performed. When the command is released, the action stops.
Two-hand controls	Human-controlled controls require two manual controls to be operated simultaneously to perform an action.
P.P.E.	Personal protective equipment. They include all the items necessary to ensure the protection of personnel from possible accidental damage (safety shoes, gloves, helmet, and more).
Display	It is used to display information. It can be in any shape and size, even touch screen.
Manufacturer	Natural or legal person who designed and manufactured the component covered by this manual.
Icon	A small image that represents a command, a function or even a document or an operating program, which appears on a computer screen. When selected by the user, it initiates the function or program it symbolizes.
Joystick	Lever manipulator used in control panels.
N.A.	Not Applicable, i.e. it indicates that it is a field that does not apply to this manual and that it cannot be integrated into the component.
Operator panel	A control station where the machine control instruments are located
P.I.	Possible Implementation, i.e. it is currently absent from the component described in this manual, but it is possible to make an addition and implement it.
Screen	Interface system between man and component. Screenshots are the images displayed on the operator panel that allow the user to receive and provide information to the management software.
Push-button panel	Composition of buttons and selectors that allow you to act directly on the behavior of the component.
Keyboard	Keyboard only (stand-alone element) or in addition to a display (keys only, no selectors or other)
Touch screen	Touch screen that allows the user to interact with a graphic interface using their fingers or objects.

1.5 Service and manufacturer contact details

For any reason relating to the use, maintenance or request of spare parts, the customer must contact the manufacturer (or the service center if present) directly, specifying the identification data of the component.

The customer can make use of the technical and commercial support of local agents or importers, who are in direct contact with the company DAV Tech Srl.

Company name	DAV Tech Srl
Postal address	Via Ravizza, 30, 37065, Montecchio Maggiore (VI) – (IT)
Telephone	+39 0444 574510
Fax	+39 0444 574324
email	davtech@davtech.it
Website	www.davtech.it

2 PRESENTATION AND OPERATION

This metering valve is an electro-pneumatically controlled component designed for precision dispensing of low and medium viscosity fluids at very high metering frequencies. Its idle state is normally closed, i.e. without pneumatic power the valve does not dispense fluid, since there is a safety spring inside the component. Maintaining a supply of at least 6 bar at its inlet and the control arrives at the solenoid valve, then the valve begins to dose. This action can be modulated both by adjusting the fluidic pressure at the inlet but also by adjusting the opening of the needle, present on its upper part.

In other words, the function of this component is:

PRECISION DISPENSING OF LOW AND MEDIUM VISCOSITY FLUID AT HIGH FREQUENCY

Intended use is the use described in the chapter below, while improper use is considered any other use that is not described in this manual, with products of different material and format from those for which it was built.

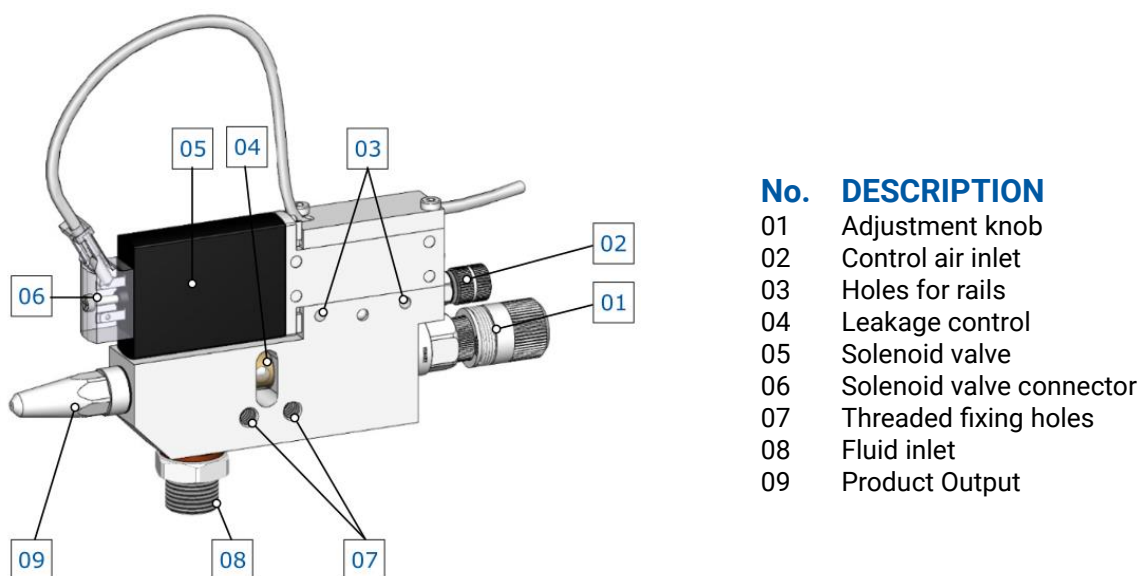

Figure 01 – Detail of the DA 400 EVO

Before using a certain type of fluid, it is necessary to check that:

- The viscosity of the fluid is compatible with the characteristics of the valve;
- The characteristics of the fluid meet the desired requirements;
- The technical data sheet of the fluid provided by the manufacturer contains all the information regarding the product such as viscosity, applications, drying times and storage;
- The fluid storage time has not been exceeded;
- The fluid packages are tightly sealed.

If it is necessary to use several fluids with the same valve, it must be cleaned thoroughly to prevent residues from the previous processing from affecting the processing to be performed.

OPERATION

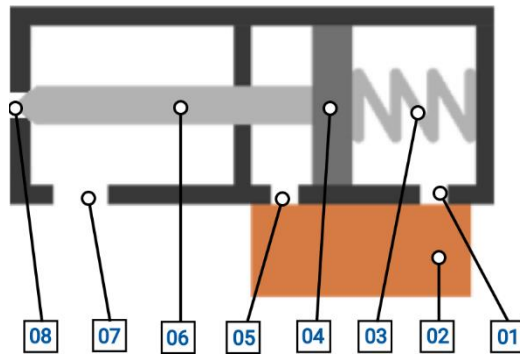

No.	DESCRIPTION
01	Air inlet closing
02	Solenoid valve 5/2
03	Spring
04	Piston
05	Air inlet opening
06	Pin
07	Fluid inlet
08	Needle coupling / fluid outlet

Figure 02 – DA 400 EVO internal section

The valve is included with a solenoid valve which, connected to the PLC, allows it to be managed with a single air inlet, leaving the PLC and the solenoid valve the task of managing opening and closing. This type of valve can only be operated as a double-acting valve; therefore, both the opening and closing of the valve itself is managed by pneumatic actuation of the 5/2 valve.

In addition, the valve can be used to perform two types of dispensing:

- Line mode, in which fluid continuously exits the nozzle;
- Jet mode, in which a very rapid and localized dosage is performed.

It should also be noted that the solenoid valve used in this application is a quick-exchange valve, i.e. it allows a change of state to be performed very quickly compared to other solenoid valves, leading to dosages at high frequencies.



ATTENTION!

To use jet mode, ask the manufacturer for more information, as there are many aspects to consider to perform an optimal dosage.

The valve cannot operate autonomously. To ensure that it dispenses product, it must be connected to a power source, which can be a tank, a pump or other, depending on the system and the customer's needs.



ATTENTION!

It is recommended that the valve be connected to the sources indicated in this manual in [chapter 2.2](#). Connecting it to other sources or products with features not listed in this manual may break the valve.

The valve is also equipped with a flow regulator, which is used to determine how much product to dose. In practice, the adjustment of the pin determines, together with the pressure of the material and the opening time, the quantity of product dispensed. To use the knob (or the set screw), you can turn clockwise to decrease the stroke of the needle and, therefore, the amount of fluid dispensed (until it is completely closed); Turning in the other direction increases the amount of fluid delivered.

Below we want to explain the operation of the DA 400 EVO valve section. Note that blue indicates the fluid inlet/outlet, yellow the air, when present.

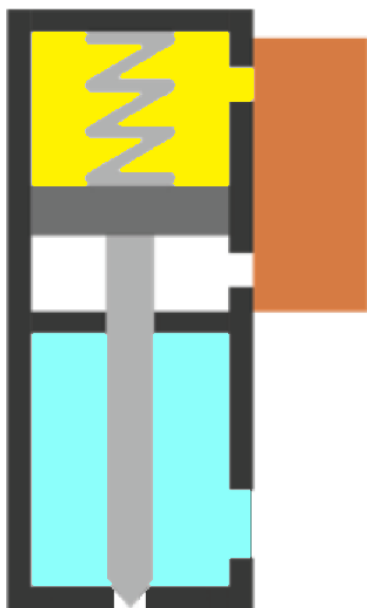

Figure 03 – Resting phase

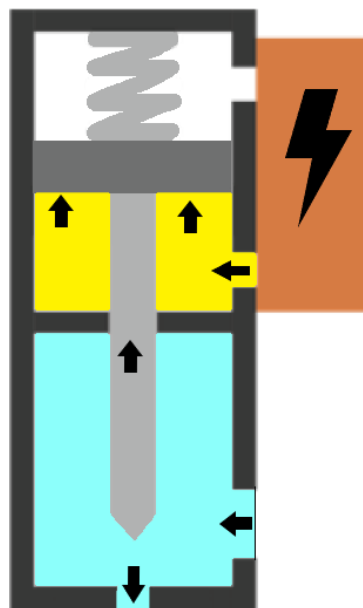

Figure 04 – Dosing phase

During the resting phase, the fluid is inside the fluidic chamber but cannot escape because the pin completely closes the product outlet hole. This needle is held in place both by a spring, but also by the pneumatic system, which, thanks to the 5/2 solenoid valve, lets air in through the closing inlet. When the signal comes from the PLC to open the valve, the PLC commands the solenoid valve to change the pneumatic inlet, letting air in from the opening inlet. From here, the piston rises, compressing the spring, and causing the needle to rise. This opens the fluid outlet nozzle and lets the fluid through.

To sum up, therefore, the valve works with these phases:

- The fluid is in the special chamber ready to exit, but the hole is closed by the needle which is held in position thanks to the pneumatic pressure that is piloted by the solenoid valve 5/2 (Figure 03);
- When the PLC controls the dosing, the PLC itself sends a signal to the solenoid valve;
- The solenoid valve changes output, passing air inside the valve opening hole;
- The piston is raised, which raises the needle, thus allowing dosing to be carried out (Figure 04);
- At the end of dosing, the PLC sends the output change signal to the solenoid valve, which passes air towards the closing inlet;
- The air, together with the spring, push the piston downwards, closing the product outlet hole (Figure 03).

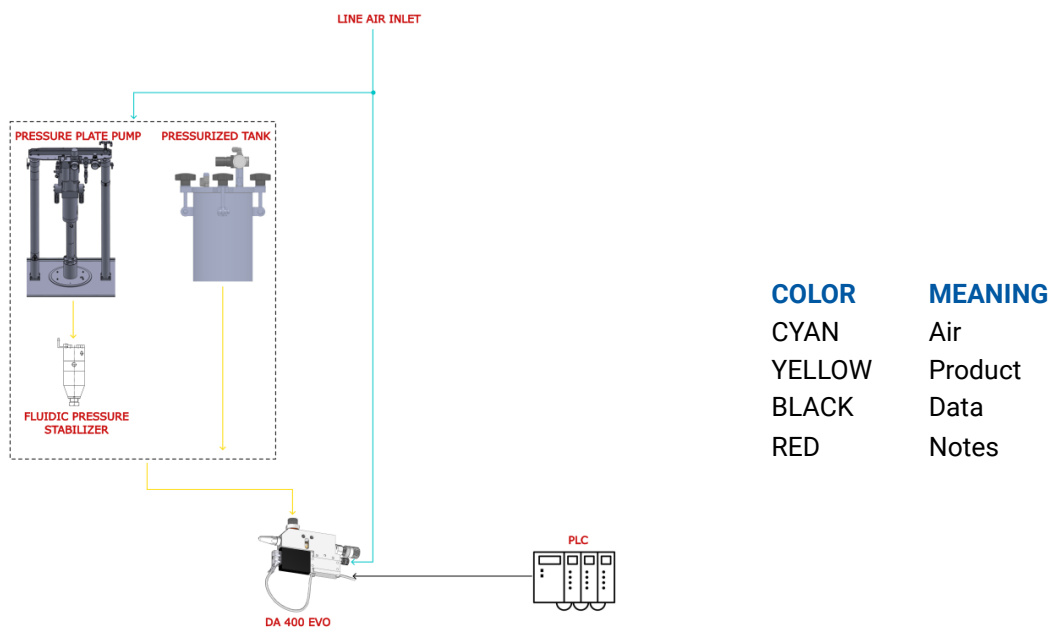

Figure 05 – Connection example

Figure 05 shows the most complete case. For minimum working pressures, please refer to [Chapter 2.2](#).



ATTENTION!

The air entering the valve must be filtered and without water (dried), otherwise it risks forming oxide inside the component and wearing it out more quickly.

2.1 Exploded

The following is a list of the main valve components with spare part numbers.

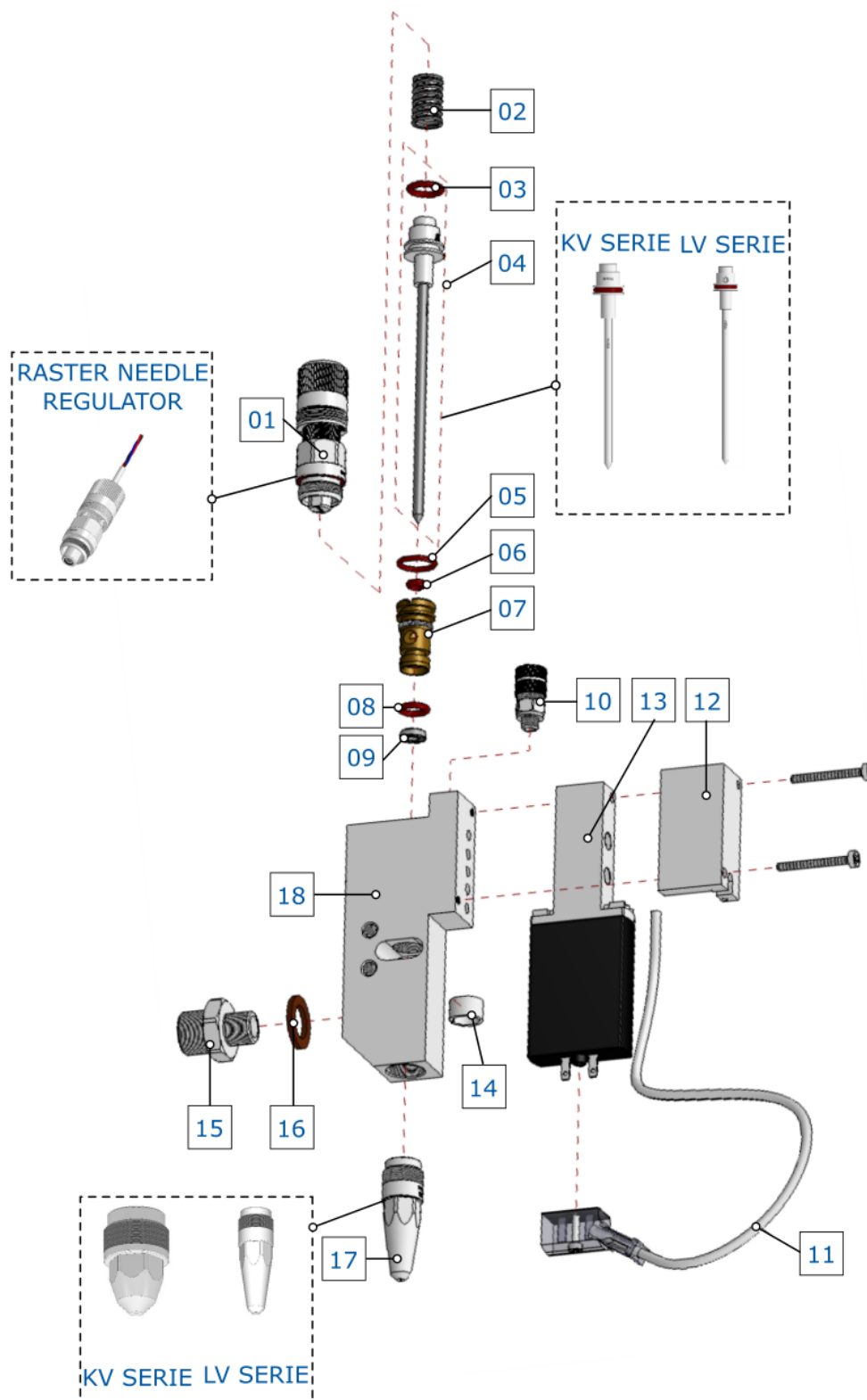

No.	Description	Var.	Code	Variant details
01	MICROMETRIC ADJUSTMENT	-	900051	-
02	SPRING	-	820020	-
03	O-RING	-	640001	-
04	COMPLETE PIN	-	-	-
-	-	04.a	112455	Carbide Nozzle Needle, KV, 0.2/0.3mm, Complete
-	-	04.b	114229	Carbide Nozzle Needle, KV, 0.4mm, Complete
-	-	04.c	112459	Carbide Nozzle Needle, KV, 0.5mm, Complete
-	-	04.d	114363	Carbide Nozzle Needle, KV, 0.6/0.7mm, Complete
-	-	04.e	112457	Carbide Nozzle Pin, KV, 0.8/1.0mm, Complete
-	-	04.f	113813	Carbide Nozzle Needle, KV, 1.2mm, Complete
-	-	04.g	113754	Carbide Nozzle Needle, KV, 1.5mm, Complete
-	-	04.h	113117	Carbide Nozzle Pin, KV, 2.0/2.5mm, Complete
-	-	04.i	112456	Carbide Nozzle Needle, LV, 0.2/0.3mm, Complete
-	-	04.j	112458	Carbide Nozzle Pin, LV, 0.4mm, Complete
-	-	04.k	112461	Carbide Nozzle Needle, LV, 0.5mm, Complete
-	-	04.l	112490	Carbide Nozzle Needle, LV, 0.6/0.7mm, Complete
-	-	04.m	112460	Carbide Nozzle Needle, LV, 0.8/1.0mm, Complete
-	-	04.n	113812	Carbide Nozzle Needle, LV, 1.2mm, Complete
-	-	04th	114364	Carbide Nozzle Needle, LV, 1.5mm, Complete
-	-	04.p	113265	Carbide Nozzle Needle, LV, 2.0/2.5mm, Complete
05	O-RING	-	640046	-
06	O-RING	-	640026	-
07	COLLET	-	810013	-
08	O-RING	-	640021	-
09	SCRAPER	-	640004	-
10	AIR CONNECTION	-	220089	-
11	SOLENOID VALVE CONNECTOR	-	150127	-
12	INTERFACING BRACKET	-	910344	-
13	SOLENOID VALVE 5/2 FESTO	-	150126	-
14	PLASTIC PROTECTIVE SLEEVE	-	640101	-
15	DOUBLE NIPPLE, STAINLESS STEEL	-	220114	EXTERNAL THREAD: 1/4"; INTERNAL THREAD: 1/8"
16	COPPER GASKET	-	640058	-
17	NOZZLE	-	-	-
-	-	17.a	210143	Nozzle, KV, 0.2 mm. stainless steel
-	-	17.b	210144	Nozzle, KV, 0.3mm. stainless steel
-	-	17.c	210145	Nozzle, KV, 0.4mm. stainless steel
-	-	17.d	210146	Nozzle, KV, 0.5 mm. stainless steel
-	-	17.e	210147	Nozzle, KV, 0.6 mm. stainless steel
-	-	17.f	210148	Nozzle, KV, 0.7 mm. stainless steel
-	-	17.g	210149	Nozzle, KV, 0.8mm. stainless steel
-	-	17.h	210150	Nozzle, KV, 1.0 mm. stainless steel
-	-	17.i	210151	Nozzle, KV, 1.2 mm. stainless steel
-	-	17.j	210152	Nozzle, KV, 1.5 mm. stainless steel
-	-	17.k	210153	Nozzle, KV, 2.0mm. stainless steel
-	-	17.l	210132	Nozzle, LV, 0.2 mm. stainless steel
-	-	17.m	210133	Nozzle, LV, 0.3 mm. stainless steel
-	-	17.n	210134	Nozzle, LV, 0.4 mm. stainless steel
-	-	Article 17	210102	Nozzle, LV, 0.5 mm. stainless steel
-	-	17.p	210136	Nozzle, LV, 0.6 mm. stainless steel
-	-	17.q	210137	Nozzle, LV, 0.7 mm. stainless steel
-	-	17.r	210138	Nozzle, LV, 0.8mm. stainless steel
-	-	17.s	210139	Nozzle, LV, 1.0mm. stainless steel
-	-	17.t	210140	Nozzle, LV, 1.2mm. stainless steel
-	-	17th U	210141	Nozzle, LV, 1.5mm. stainless steel
-	-	17.v	210142	Nozzle, LV, 2.0mm. stainless steel
18	DA-400 EVO MAIN BODY	-	511051	-
-	COMPLETE GASKET KIT	-	GASKETKIT-DA400EVO	-
-	RASTER PIN BLOCK	-	900053	Raster pin regulator, Ø15x45mm min.

COD.: DTVI_DA400EVO_2404
 REV.: 00
 DATE: 06/05/2024

DAV TECH SRL

Any reproduction (total or partial) of this document not authorized by the manufacturer will be punished according to the law.



2.2 Technical data

All the technical characteristics concerning the component of this manual are indicated below.

SPECIFICATIONS		
Description	UdM	Values
Model	\	DA 400 EVO
Activation	\	Double Acting
Solenoid valve power supply	VDC	24
Solenoid valve power consumption	W	2
Minimum electrical cable cross-section	mm	0.35
Maximum fluid pressure (with actuating air)	bar	100
Maximum fluid pressure (without drive air)	bar	30
Minimum pneumatic pressure	bar	6
Step per micrometer shot	mm/click	0.01
Pin lift every 360° micrometric	mm	0.5
Maximum frequency of use dosage	Hz	200
Air inlet thread	\	M5
Air inlet hose	Mm	6x4
Fluid inlet thread	\	1/4 GAS
Fluid outlet thread	\	LV nozzle
		KV Nozzle
Maximum control frequency	cycles/min	300
Passage adjustment	\	Micrometric
Materials used	\	Stainless steel
		Widia
		Nickel-plated and Teflon-coated brass

ATTENTION!

With inlet fluid pressures above 8 bar, use reinforced hoses

ENVIRONMENTAL CHARACTERISTICS		
Description	UdM	Values
Working Ambient Temperature	°C	5 ÷ 45
Storage Ambient Temperature	°C	-20 ÷ 55
Permissible non-condensing humidity	%	5 ÷ 90

USABLE FLUIDS
Silicones
Liquid gaskets
Oil
Grease

Miscellaneous products with low - medium viscosity (contact the manufacturer for more information)

DIMENSIONAL AND WEIGHT CHARACTERISTICS

Description	UdM	Value
Component length (min ÷ max)	mm	125 ÷ 143
Component depth (min ÷ max)	mm	15
Component height (min ÷ max)	mm	58
Component weight	kg	0.39

Component

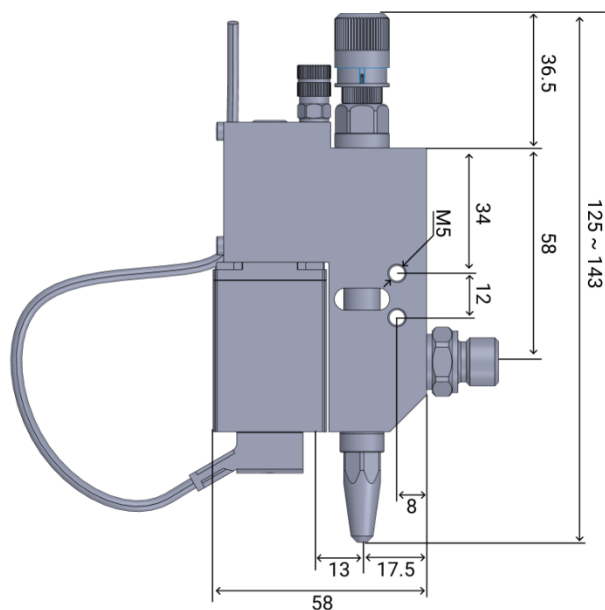

You can request the 3D of the component in the desired version from the manufacturer without any obligation.

3 SAFETY

The following is a list of warnings regarding the component covered by this manual. Please read carefully before proceeding to the next chapters.



DANGER!

Before operating the component or performing any action on it, read this manual carefully.



DANGER!

Do not use the component while under the influence of drugs or other substances that may impair attention and reaction ability.



DANGER!

Operators must only perform operations or interventions that are within the competence of the role and qualification assigned.



FIRE/EXPLOSION HAZARD!

This component is not designed to work in an ATEX environment.



DANGER!

Be very careful when servicing the component, especially when disassembling components that have pressure springs inside.



ATTENTION!

Modifications to the component must not be made to achieve performance other than that for which it was designed and built, unless authorized by the manufacturer.



ATTENTION!

Avoid introducing foreign bodies, even small ones, into the pneumatic system, which could cause the system to malfunction and compromise the safety of the machine.



The component may only be used by trained and authorized operators and for the sole purpose for which it was designed and manufactured.



The component is manufactured in compliance with the technical safety standards in force at the time of its construction.

3.1 Component safety devices

N.A.

3.2 Free useful spaces

N.A.

3.3 Risk areas and residual risk

There are the following residual risks on the component:

- **Dangers due to electricity:** the passage of pressurized fluid generates static electricity which, if touched by personnel who are not properly isolated, can be dangerous;
- **Hazards due to inhalation of hazardous vapors:** The component is not designed to have insulation from any toxic and/or hazardous vapors; personnel working with this device should be aware of this during its use;
- **Fire hazard due to vapors:** Personnel working near this component must not have any heat sources that could start a fire;
- **Risk due to fluid projection under pressure:** Due to incorrect maintenance of the component, it can lead to the expulsion of some parts of the component and consequent expulsion of fluid.

4 TRANSPORT AND HANDLING

Once you have received the goods, you must check that the packaging is intact and that there is an exact correspondence with the material ordered.



ATTENTION!

The original configuration of the component must not be changed. The manufacturer is not liable for damage caused by inappropriate use of the component.



ATTENTION!

If the packaging is not intact, contact the manufacturer immediately, also sending photos of the condition of the packaging. Do not open it until you have notified the manufacturer.

5 INSTALLATION



The installation of the component is carried out by the customer. If necessary, you can contact the manufacturer to have a specialist technician help you.

The valve has been designed to be used in the following cases:

- Work independently as a fluid dispenser on a pressure/time basis;
- Work in tandem with a positive displacement pump to dose the fluid in a volumetric way.

It is also equipped with two calibrated seats (No. 03, figure 01, [chapter 2](#)) to have perfect centering both during installation and after maintenance. It is also advisable to fix it well to the support using special screws (No. 03, figure 01, [chapter 2](#)), as the vibrations that are caused by the machinery in operation could take the valve off-center, resulting in a dosage that is not optimal.



It is recommended that you perform a component check before beginning the installation. If it is evidently damaged, please contact the manufacturer.



ATTENTION!

Please remove the packaging with the utmost care. If damage is caused to the component, the manufacturer is not liable.



Dispose of the packaging correctly, considering the different nature of the components and following the regulations in force in the country.

5.1 Positioning







N.A.

5.2 Connections

In this chapter, we want to explain the connection method that must be used for the component. The following types of connection are provided:

- Electrical connection;
- Pneumatic connection;

5.2.1 Electric

Authorized personnel	 PPE to wear					
Component status	PLC installed, with outgoing communication cable					
Power Values	See chapter 2.2					
Necessary preparations	Electrical cable with correct power supply					
Materials needed	N.A.					
Equipment needed	N.A.					



The electricity connection is at the expense of the customer.







To make the electrical connection, the electric cable (which must comply with the specifications given in [chapter 2.2](#)) must be connected to the appropriate socket, which can be reached in this way:

01

N.A.

- Unscrew the two screws that hold the interfacing bracket (No.12 [chap.2.1](#))
- Feed the appropriate connector of the solenoid valve (No.11 [chap.2.1](#)) until it is connected to the appropriate socket (No.06, figure 01, [chap.2](#));
- Replace the interfacing bracket, taking care not to pinch the cable.

5.2.2 Pneumatic

Authorized personnel	 PPE to wear					
Component status	Component installed and turned off					
Power Values	See chapter 2.2					
Necessary preparations	Working pneumatic air system					
Materials needed	Fixing screws (for centering holes)					
Equipment needed	Wrench or screwdriver					



The pneumatic connection is the responsibility of the customer.

Before assembling the valve, it is recommended to calibrate it, so as to perform it precisely and once performed, you can proceed with the assembly and possible fixing by screws passing through the centering holes. For connections, it is recommended to connect the pneumatic hose first and then proceed with the connection of the product hose, using the data given in [chapter 2.2](#).

5.3 Commissioning

The commissioning of the component is carried out once the positioning and connection of the connections has been completed. Before commissioning the component, the following checks must be carried out:

- Check that the connections have been connected correctly;
- Check that the component is free of dirt or residues of various kinds;



ATTENTION!

If even one of the above points does not comply, commissioning must not be carried out. Commissioning should only be carried out when all points have been successfully completed.

6 SOFTWARE

N.A.

7 PROCEDURE

In this chapter we want to explain the main configurations that can be used on the component covered by this manual. In particular, we want to explain in detail:

- How to perform needle adjustment by micrometric adjustment;
- How to install the raster pin block

Note that the flow of the outgoing fluid depends on the following factors:

- **Nozzle diameter:** the larger the nozzle diameter, the higher the flow rate of fluid at the outlet;
- **Fluid pressure:** the higher the fluid pressure, the higher its outlet flow rate;
- **Needle stroke adjustment:** The larger the needle stroke, the higher the flow rate.

7.1 Micrometric adjustment

In this case, the adjustment knob must be adjusted (see [chapter 2](#), figure 01, number 01), to adjust the amount of fluid dispensed with extreme precision, namely:

- Turn counterclockwise to increase the needle stroke and therefore the amount of fluid dispensed;
- Turn clockwise to decrease the needle stroke and therefore the amount of fluid dispensed. If you reach the end of the stroke, the valve is completely closed and, therefore, there is no fluid delivery.



ATTENTION!

Once you reach the stop (0% opening), you must not force the adjustment knob further as you risk ruining both the needle and the nozzle.

7.2 Raster Pin Block Installation

In this chapter we want to explain how to make the connections of the raster needle block, which is a sensor that automatically detects when the needle has performed ALL its travel.



ATTENTION!

Be careful during the installation phase to adjust the raster correctly. Incorrect adjustment could ruin the inner needle of the valve.

- Remove the screw or micrometric adjustment and install the raster needle block;
- Turn counterclockwise until it is in stop;
- Open the valve, to bring the valve needle as close as possible to the block;
- Turn the raster pin block clockwise until it is at the pin stop;
- Turn counterclockwise 14 clicks (about 1/4 turn of the knob);
- For electrical connections, follow the diagram below.

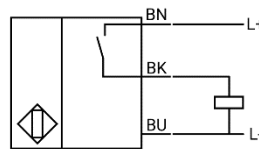

- See if the sensor works by opening and closing the valve;



If the sensor remains off all the time, it means that it does not detect the pin, and you have to move it closer (clockwise);

8 MAINTENANCE

Maintenance interventions are all those activities that must be performed on the component which, if carried out correctly, allows it to have a longer life. In general, maintenance is divided into two groups:

- **Ordinary maintenance**, which are interventions on a regular basis or that can be carried out by the customer's staff, are the most important activities as they allow the component to be kept in good working condition;

**ATTENTION!**

Ordinary maintenance must be carried out in the manner and timing indicated in the following chapters.

- **Extraordinary maintenance**, i.e. all those interventions that are not regularly carried out or that have not been planned, or interventions that cannot be carried out by the Customer. They can also arise from the lack of routine maintenance.

**ATTENTION!**



Extraordinary maintenance work must be carried out together with the manufacturer's specialized technicians.

Regarding attendance, it must be considered that:

- **When necessary**: Operation to be carried out when the need to be carried out is seen;
- **Every machine start or job end**: Indicates a daily period, in general. This can imply every 24 hours (i.e. at the beginning of the shift of every day, or the end of the shift of every day), or even more frequently, depending on the application;
- **Long pause**: Indicates a period approximately greater than an hour;
- **Each drum change**: Indicates each time the fuel system (tank, drum, cartridge or other) is changed;
- **Each mixer disassembly**: Indicates that each time the mixer is replaced, a certain operation must be performed;
- **Weekly**: Indicates a period equal to seven calendar days;
- **Monthly**: Indicates a period equal to one calendar month;
- **Semi-annual**: Indicates a period equal to six calendar months;
- **Yearly**: Indicates a period equal to one calendar year.

**ATTENTION!**

The times given below are indicative as they depend on how the component is used. Follow the variations suggested by the technicians.

Assigned	Description	Frequency	Chapter
	Perform a test function of the valve	Every machine start-up or end of work	\
	Perform a surface cleaning of the valve	Every machine start-up or end of work	\
	Cleaning and/or replacing the nozzle	Semiannual	8.1
	Disassembly and reassembly of the valve	Annual	8.1



ATTENTION!

Apply the tip of petroleum jelly grease at the end of the work and at every prolonged pause in the system, to preserve the fluid inside the system and the functionality of the valve itself



ATTENTION!

Only use soft brushes or cotton cloths to clean the valve.

8.1 Disassembly and reassembly of the valve

Assigned	Periodicity	Materials and equipment
	Annual	<ul style="list-style-type: none"> • Key of 10 and 13; • 3mm hex screw; • Narrow-nose pliers; • Phillips screwdriver PH1; • Slotted screwdriver 1.6x10.

PPE to wear



ATTENTION!

Before performing this procedure, it is necessary to relieve the pressure from the system and disconnect the air connection, as well as to disconnect the power to the circuit.



ATTENTION!

There are compression springs inside the assembly. Be especially careful throughout the disassembly and reassembly of the valve



ATTENTION!

Always install a new needle and nozzle at the same time



ATTENTION!

When installing the micrometer regulator or clamping screw, pay particular attention that the thread is inserted correctly, i.e. perpendicular to the body, and not that it is inclined.

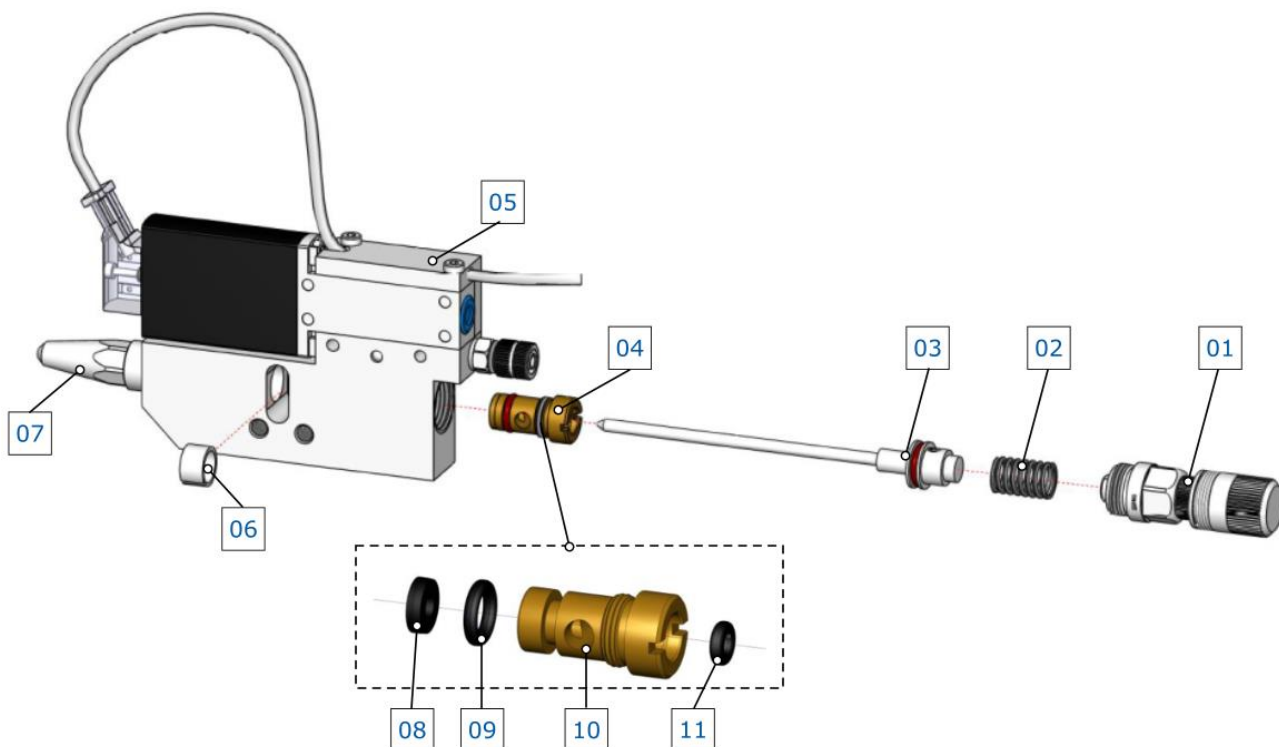

- Remove the micrometric adjustment (01);
- Remove the spring (02) and remove the needle (03) from the main body (05). Be careful not to lose the spring during this phase;
- Unscrew the nozzle (07);
- Remove the protective plastic sleeve (06);
- Unscrew the sleeve (04) from the main body using a special flat screwdriver;
- Remove gaskets 08, 09 and 11;
- Using a special grease (generic or petroleum jelly), put the gaskets back in place, paying particular attention not to damage them and to the direction of the gasket 08 (lip towards the nozzle);
- Cover the sleeve (04) with special grease to avoid damaging the gaskets when it is put back in place;
- Screw the sleeve into place;
- Replace the protective plastic sleeve;
- If necessary, change the nozzle and needle and fit the new components;
- Put the spring back in place;
- Replace the micrometer adjustment.

9 TROUBLESHOOTING

This chapter deals with the most common problems that may arise when using the component of this manual.



ATTENTION!

Once the operator has found a problem or assumes that there is a problem, they must call the technician in charge of maintenance. Maintenance should always be performed by a specialized and qualified technician.

DEFECT	CAUSE	SOLUTION
Low fluid output or no fluid	The valve does not receive the command	Check the valve control (solenoid valve). Perform a manual test
	Fluid pressure is too low or no	Check the pressure of the fluid supply unit and increase it if necessary
	The nozzle is clogged	Unscrew and clean the nozzle
	The filter is dirty (if any)	Wash or replace the filter
	A tube is kinked	Check the condition of the fluid supply hoses
	Insufficient operating pressure	Check the actuation pressure (chap. 2.2)
Fluid leaking from the collet	Fluid residues present in the system	Disassemble and clean any solid particles
	Damaged scraper	Replace the scraper
Nozzle drips even if valve is not piloted	Damaged pin	Replace the pin
	Dirt in the nozzle	Clean or replace the nozzle
	Damaged needle (or nozzle)	Overhaul the valve
	Insufficient operating pressure	Check the actuation pressure (chap. 2.2)
Valve opens late	Pin stuck inside the sleeve	Clean the collet
	Pin stroke too short	Increase the needle stroke
	Solenoid valve does not discharge air	Check the solenoid valve
	O-Ring on Damaged Air Piston	Replace O-Ring on Pneumatic Piston

10 END OF LIFE

End-of-life refers to all those activities that put the component out of service. End-of-life activities can be:

- **Storage**, i.e. when the component is placed inside the warehouse for an unspecified period waiting for a third party to buy the component;
- **Dismantling**, i.e. when the component has reached the end of work period, whether it is due to age, obsolescence or faults that cannot be repaired, or that it is possible to repair but it is worth buying a new component.

If installation is not planned soon, the component can remain packaged and must be stored in a sheltered and preferably closed place. The ambient temperatures to be observed are given in [chapter 2.2](#).

On the other hand, for the dismantling and consequent scraping of the component or its parts, the different nature of the various components must be considered, and a differentiated scrapping must be carried out. We recommend that you commission specialist companies for this purpose and must always observe the applicable laws on waste disposal.